

LokPilot V4.0

Instruction Manual

3rd Edition, May 2011

LokPilot V4.0

LokPilot V4.0 DCC

LokPilot micro V4.0

LokPilot micro V4.0 DCC



1. Declaration of conformity	4	6.7.4. Motor and Track Connections.....	15
2. WEEE-Declaration (Europe only)	4	6.7.4.1. Connecting DC and Coreless Motors	15
3. Important Notes – Please read this chapter first...	5	6.7.4.2. Connecting Universal Motors with HAMO-Conversions	16
4. How this manual helps you	6	6.8. Connecting additional Functions.....	16
5. Introduction – The LokPilot Family	6	6.8.1. Overload Protection of Function Outputs (blinking) ..	16
5.1. The Members of the LokPilot Family.....	6	6.8.1.1. Suitable Light Bulbs.....	16
5.1.2. LokPilot V4.0	6	6.8.2. Connecting the Light Outputs, AUX1 and AUX2.....	16
5.1.1. LokPilot V4.0 Decoders – An overview	7	6.8.3. Purpose of AUX3 and AUX4	17
5.1.3. LokPilot V4.0 DCC	7	6.8.3.1. LokPilot with 21MTC Interface.....	17
5.1.4. LokPilot micro V4.0	7	6.8.4. Suitable Smoke Generators	17
5.1.5. LokPilot micro V4.0 DCC.....	7	6.9. Connecting Capacitors.....	18
5.2. General Properties of all Decoders.....	8	6.9.1. All LokPilot H0	18
5.2.1. Operating Modes.....	8	6.9.2. Optional „PowerPack“	18
5.2.2. Motor Control	8	7. Initial Operation	19
5.2.3. Analogue Mode.....	9	7.1. Factory Default Values.....	19
5.2.4. Functions	9	7.2. Digital Operating Modes.....	20
5.2.5. Programming	9	7.2.1. DCC Mode	20
5.2.6. Operational Reliability	9	7.2.1.1. DCC Speed Steps („flashing lights“)	20
5.2.7. Protection	9	7.2.1.2. Auto-detection of DCC Speed Steps	20
5.2.8. Future built-in	9	7.2.2. Motorola® Mode.....	21
6. Installing the Decoder	10	7.2.2.1. 28 Speed Steps.....	21
6.1. Requirements for Installation.....	10	7.2.2.2. Extended Motorola® Address Range	21
6.2. Installing the Decoder	10	7.2.3. Selectrix® Mode	21
6.3. Locomotives with 8-pin NEM 652-Interface.....	10	7.3. Analogue Mode.....	22
6.4. Locomotives with 6-pin NEM 651-Interface.....	11	7.3.1. Analogue DC operation	22
6.5. Locomotives with 21MTC Interface	12	7.3.2. Analogue AC Operation	22
6.5.1. Connecting C-Sine motors („SoftDrive-Sinus“)	12	8. Decoder Settings (Programming)	23
6.6. Locomotives with PlUX Interface	12	8.1. Adjustable Properties of Decoders.....	23
6.7. Locomotives without Interface	12	8.1.1. Configuration Variables (CVs)	23
6.7.1. Wiring Diagram for LokPilot.....	13	8.1.1.1. Standardisation in the NMRA	23
6.7.3. Colour Coding by Märklin®.....	15	8.1.1.2. Bits and Bytes	24
		8.2. Programming with popular Digital Systems	24
		8.2.1. Programming with DCC Systems	25
		8.2.2. Programming with the ESU ECoS	25
		8.2.3. Programming with Märklin® 6021	25
		8.2.3.1. Changing the Programming Mode.....	26

8.2.3.2. Short Mode	26	11.1.1. Parameter for frequently used Motors.....	34
8.2.3.3. Long mode	26	11.1.2. Adjustments for other Motors / „Fine Tuning“	34
8.2.4. Programming with the Märklin® Mobile Station®	27	11.1.2.1. Parameter „K“	34
8.2.5. Programming with the Märklin® Central Station	27	11.1.2.2. Parameter „I“	34
8.2.6. Programming with the ESU LokProgrammer	27	11.1.2.3. Reference Voltage	35
9. Address Settings	28	11.1.2.4. Parameter “K slow”	35
9.1. Short Addresses in DCC Mode	28	11.1.2.5 Adaptive Regulation Frequency	35
9.2. Long Addresses in DCC Mode	28	11.2. Turning off Load Compensation	36
9.3. Motorola® Address	28	11.3. Adapting Load Control Frequency	36
10. Adapting the Driving Characteristics	29	11.4. Dynamic Drive Control: Up and Down the Hill	36
10.1. Acceleration and Deceleration	29	11.5. Settings for the C-Sinus Motor	36
10.1.1. Switching Acceleration / Deceleration	29	12. Function outputs	37
10.1.2. Shunting Mode	29	12.1. Physical function outputs	37
10.2. Starting Voltage, Maximum and Medium Speed	29	12.2. Allocation of Function Buttons (Function Mapping)	37
10.3. Speed Curve	30	12.2.1. Index CV access	37
10.4. Changing between Operating Modes	30	12.2.2. Function Mapping - Chart	38
10.4.1. Changing from Digital to Analogue DC	30	12.2.3. Allocation of Function Keys with LokProgrammer	38
10.4.2. Changing from Digital to Analogue AC	30	12.3. Special Effects on Function Outputs	39
10.4.3. Changing from Analogue to Digital (directional bit)	30	12.3.1. Switching on Outputs and Different Options	39
10.4.4. Changing from Digital to Digital	31	12.3.2. Adjusting the Lighting Effects	39
10.4.5. Changing modes with Analogue Mode turned off	31	12.3.3. Grade Crossing holding time	43
10.5. Brake Sectors	31	12.3.4. Flash Rate	43
10.5.1. DC Brake Mode	31	12.3.5. Digital Couplers	43
10.5.2. Märklin® Brake Mode	31	12.3.5.1. Operation mode „Coupler“	43
10.5.3. Selectrix® Diode Brake Sector	32	12.3.5.2. Automatic „Coupler“ Function (Pushing/Removing)	43
10.5.4. Lenz® ABC Brake Mode	32	12.4. Analogue Settings	44
10.6. Constant Brake Distance	32	12.5. LGB® Pulse Sequence Mode	44
10.6.1. Linear Brake Distance	33	12.6. Swiss Headlight Mode	44
10.6.2. Constant Linear Brake Distance	33	13. Decoder Reset	45
10.7. Settings for Analogue Operation	33	13.1. With DCC Systems or 6020/6021	45
10.7.1. DC Analogue Operation	33	13.2. With Märklin® systems (M4-decoders only)	45
10.7.2. AC Analogue Operation	33	13.3. With the ESU LokProgrammer	45
11. Motor Control	34	14. Special Functions	45
11.1. Adjusting Load Compensation	34	14.1. Directional Bit	45

15. RailCom®	46
16. Firmware Update	46
17. Accessories	46
17.1. Change over skis.....	46
17.2. HAMO Magnets.....	46
17.3. Wire Harnesses with 8-pin or 6-pin Socket.....	47
17.4. Mounting Adapter 21MTC	47
19. Support and Assistance	47
20. Technical Data	48
21. List of all supported CVs	49
21.1. DCC Decoders	49
22. Appendix	54
22.1. How to programm long addresses	54
22.1.1. Write address.....	54
22.1.2. Read address	54
23. Warranty card	67

1. Declaration of conformity

We, ESU electronic solutions ulm GmbH & Co KG, Industriestraße 5, D-89081 Ulm, declare in sole responsibility that the products to which this declaration refers, namely

LokPilot V4.0, LokPilot V4.0 DCC, LokPilot micro V4.0, LokPilot micro V4.0 DCC

are in compliance with the following standards:

EN 71 1-3 : 1988 / 6 : 1994 – EN 50088 : 1996 – EN 55014, part 1 + part 2 : 1993

EN 61000-3-2 : 1995 – EN 60742 : 1995 – EN 61558-2-7 : 1998 according to the directive

88 / 378 / EWG – 89 / 336 / EWG – 73 / 23 / EWG

2. WEEE-Declaration

Disposal of obsolete electrical and electronic equipment (as practised in the European Union and other European countries with dedicated collection systems).



This mark on the product, the packaging or the relevant documentation indicates that this product must not be treated like household waste. Instead this product should be disposed of at a suitable collection point for recycling of electrical and electronic appliances. Thus you contribute to avoid negative impact on the environment and people's health that could be caused by inappropriate disposal. Recycling of materials contributes to preserve our natural resources. For more information regarding recycling of this product, please contact your local administration, your waste collection service or the dealer / shop where you purchased this product.

3. Important Notes – Please read this chapter first

We congratulate you to your purchase of an ESU LokPilot decoder. This manual will guide you step by step through the features of your LokPilot decoder.

Please read this manual carefully. Although the LokPilot has been design as a robust device an incorrect connection may lead to faults or even to the destruction of the device. Avoid any "costly" experiments.

Copyright 1998 - 2010 by ESU electronic solutions ulm GmbH & Co KG. Electrical characteristics and dimensions are subject to change without prior notice. All rights reserved. ESU might not be held responsible for any damage or consequential loss or damage caused by inappropriate use of the product, abnormal operating conditions, unauthorized modifications to the products etc...Not suitable for children under 14 years of age. Inappropriate use may result in injury due to sharp points and edges.

Märklin® and mfx® is a registered trademark of the company Gebr. Märklin® and Cie. GmbH, Göppingen, Germany. RailCom is a registered trademark of the company Lenz Elektronik GmbH, Giessen, Germany.

All the other trade marks are owned by their respective right holders.

ESU electronic solutions ulm GmbH & Co. KG continues to develop the products according to the company's politics. Therefore, ESU reserves the right to carry out changes and improvements on the products listed in this manual at any time and without any advanced note.

Duplications and reproductions of this documentation are strictly forbidden and need to be allowed by ESU in writing.



- The LokPilot is exclusively intended for use with model train layouts only. It may only be operated with the components listed here. Any other use is not permitted.
- Any wiring has to be carried out while power is disconnected. Please make sure that no voltage reaches the locomotive while converting it, above all not accidentally.
- Avoid mechanical force or pressure on the decoder.
- Do not remove the heat shrink sleeve on the decoder.
- Make sure that neither the LokPilot decoder nor any blank wire ends may come into contact with the engine chassis (risk of short circuit). Cover any blank ends of unused wires.
- Never solder on the circuit board, extend cables if necessary.
- Never wrap the decoder in insulation tape, since this may cause overheating.
- Adhere to the wiring principles as outlined in this manual for wiring any external components. Other circuitry may cause damage to the LokPilot.
- Make sure that no wires are squeezed or cut by the model's transmission parts when reassembling the engine.
- Any power supply must be protected by a fuse or circuit breaker to avoid any potential hazards such as burning cables in case of a short circuit. Only use transformers specifically designed for model trains that bear the VDE/EN marks.
- Never operate the LokPilot unattended. The LokPilot is not a (children's) toy.
- Do not expose to wet and humid conditions.

4. How this manual helps you

This manual is divided into several chapters that show you step-by-step how to install a LokPilot decoder.

[Chapter 5](#) provides an overview over the characteristics of each type of LokPilot decoder.

[Chapter 6](#) describes installation of the decoder in detail. Please make yourself familiar with the type of motor and the type of interface installed in your locomotive prior to working through chapters 6.2. to 6.5.

You can operate LokPilot Decoders with most commercially available control systems for model trains. [Chapter 7](#) provides an overview which digital and analogue systems can drive LokPilot decoders and which special issues to consider.



You will find the factory default settings for the function buttons in [chapter 7.1](#).

You may adjust the default settings of your LokPilot decoder as desired. [Chapters 8 to 16](#) explain which parameters are adjustable and how to do it.



We recommend, that you at least read [chapters 8 and 9](#) regarding address settings as well as [chapter 11](#) concerning motor control in order to be able to adapt your LokPilot decoder optimally to your model locomotive.

[Chapter 20](#) lists all technical data as well as supported CVs and will assist you in case of questions.



If not stated otherwise all information refers to all types of the LokPilot family. Should one particular decoder not support a specific function, then this is clearly mentioned.

5. Introduction – The LokPilot Family

5.1. The Members of the LokPilot Family

All LokPilot V4.0 decoders complement the excellent properties of their predecessors and expand their capabilities by further functions. These developments further improve the driving characteristics, the operational reliability, and the flexibility of the decoders.

The LokPilot decoder is the first choice for any sophisticated model train enthusiast that places great value on excellent load control, outstanding driving characteristics at low speed, and the utmost flexibility due to adaptation to specific requirements.

LokPilot decoders automatically detect the operating mode and are suitable for all commonly used motors. LokPilot decoders of the fourth generation offer you flexibility and reliability that you would expect from a state-of-the-art decoder. Future standards do not represent a problem either: due to the flash technology, you can update the decoder at any time.

In order to suit the different scales and the related current draw of the model locomotives, all LokPilot V4.0 decoders come in various options that we now would like to introduce to you.

5.1.2. LokPilot V4.0

The LokPilot V4.0 is a multi-protocol decoder. It supports the Märklin® Motorola® format, the DCC-format and Selectrix®.

It can also work on analogue DC or AC layouts. Thus, it is ideally suitable for mixed Motorola® / DCC environments.

Due to its manifold lighting functions and its adaptability to different applications, it is the perfect all-rounder for your H0 locomotives.

Overview of the LokPilot V4.0 Decoders

5.1.1. An overview of the LokPilot V4.0 Decoders

	LokPilot V4.0				LokPilot V4.0 DCC			LokPilot micro V4.0				LokPilot micro V4.0 DCC		
DCC Operation	Ok				Ok			Ok				Ok		
Motorola® Operation	Ok				-			Ok				-		
M4 Operation (mfx® compatible)	-				-			-				-		
Selectrix® Operation	Ok				-			Ok				-		
Analogue DC Operation	Ok				Ok			Ok				Ok		
Analogue AC Operation	Ok				-			-				-		
DCC programming mode	Ok				Ok			Ok				Ok		
Programming with 6021, Mobile/ Central Station®	Ok				-			Ok				-		
M4 programming including automatic recognition	-				-			-				-		
RailCom® option	Ok				Ok			Ok				Ok		
ABC brake mode	Ok				Ok			Ok				Ok		
Continuous motor current	1.1A				1.1A			0.75A				0.75A		
Function output current	4/250 mA				4/250mA			2/150mA				2/150mA		
Integrated PowerPack	-				-			-				-		
Buffer capacitor	Ok				Ok			-				-		
Connection type	NEM652	NEM651	21MTC	PluX12	NEM652	NEM651	21MTC	NEM651	NEM651	NEM652	Next18	NEM651	NEM651	Next18
	Harness	Harness		Harness	Harness	Harness		Direct	Cable	Cable		Direct	Cable	
Article number	54610	54612	54614	54616	54611	54613	54615	54688	54687	54683	54689	54685	54684	54686

5.1.3. LokPilot V4.0 DCC

The LokPilot V4.0 DCC is a thoroughbred DCC decoder. Except for the Motorola® and Selectrix® protocol, it supports all functions of the LokPilot V4.0. In analogue mode, it can only operate on DC powered layouts.

The LokPilot V4.0 DCC is best suited for the DCC purist who does not require multi-protocol operation and does not want to pay for it either.

5.1.4. LokPilot micro V4.0

The LokPilot micro V4.0 is a real multi talent. Besides DCC and Motorola® and Selectrix® and a maximum current draw of 0.75A, it is ideal for the small scales with little room for decoders.

5.1.5. LokPilot micro V4.0 DCC

The LokPilot micro V4.0 DCC is a real power package: with a permitted current draw of 0.75 A this DCC decoder with RailCom® option offers the best solution for small locomotives in N and TT scale as well as small H0 locomotives with limited room.

5.2. General Properties of all Decoders

5.2.1. Operating Modes

All LokPilot V4.0 decoders (with the exception of the pure DCC decoders) are true multi-protocol decoders with automatic detection of the operating mode „on-the-fly.“ The decoder analyses the track signal and filters out the part that is reserved for it. Changing from digital to analogue and back represents no problem whatsoever. This is important in case your e.g. fiddle yard still works in analogue mode. Furthermore, all LokPilot decoders support the relevant brake modes such as ROCO®, Lenz® or Märklin® and stop as intended.

Especially the ABC brake sections are suitable for a simple stop in front of the signal. LokPilot decoders achieve the maximum compatibility with the operating system in order to enable you to simulate even some unusual operational requirements.

Provided the digital system supports them, the LokPilot V4.0 supports and automatically detects the DCC protocol with 14, 28, or 128 speed steps. Of course, operation with the long 4-digit addresses is possible as well.

Contrary to the original Märklin®-decoders, LokPilot V4.0 decoders support up to 255 addresses and 28 speed steps in Motorola® mode. With the appropriate command station such as the ESU ECoS, you can expand the system limits of the Motorola® system considerably.

5.2.2. Motor Control

The most important function of digital decoders is motor control. All LokPilot V4.0 decoders are designed for universal use and therefore can control all commonly available DC motors, regardless if they are by ROCO®, Fleischmann®, Brawa®, Mehano®, Bemo®, LGB®, Hübner®, Märklin® or others.

Coreless motors (such as Faulhaber® or Maxon®) also work fine with LokPilot.

You may continue to use any universal motors provided you replace the stator coils with a permanent magnet.

You will find more info on this topic in chapter 6.7.4.2.

General Properties of all Decoders

Fifth-generation load compensation works with 20 resp. 40 kHz and assures extremely silent operation, particularly with coreless motors. Due to 10-bit technology, your locomotives will crawl at a snail's pace if so desired. Load compensation is easily adjustable to various motor and gear combinations (compare with chapter 11). With Dynamic Drive Control (DCC), you can limit the influence of load control. Thus, you can control your locomotive in small throttle notches for instance in the yard or on turnouts while the locomotive responds like the prototype at high speed on the main line (for instance when climbing a gradient). In other words, if you do not change the throttle setting then the locomotive will slow down up the hill, as does the prototype. There is more info on this in chapter 11.4.

The minimum and maximum speed of the LokPilot V4.0 is adjustable by setting three points or the speed table with 28 entries. The table is effective for all speed step ratings (14, 28, and 128 speed steps); many decoders by others do not offer this feature. Due to unique load compensation by ESU, there are no visible jerks between speed steps – even in 14-speed-step-mode.

5.2.3. Analogue Mode

Quite a few LokPilot decoders replace analogue directional relays. Therefore, you can not only set the starting speed and the maximum speed as well as pre-select which functions should be active in analogue mode: even load compensation works in analogue mode! Therefore, LokPilot V4.0 decoders are ideal for analogue locomotives: Finally, you can slow down your older, fast running locomotives.

5.2.4. Functions

Standard features for LokPilot V4.0 decoders include the following features: acceleration and brake times can be separately adjusted and switched, and of course, you can switch the shunting mode. The brightness of all function outputs can be separately set and allocated to the desired function buttons (function mapping).

There is a wide range of options: dimmer, flickering firebox, gyrolight and mars-light, flash and double flash, blinker and alternate blinker as well as switch functions with timers (e.g.: for Telex

and a special coupler function for remote controlled couplers by Krois® and ROCO®.

The unique and once more improved ESU function mapping enables you to allocate every function to the function buttons F0 to F15; even multiple allocations are possible. You will find more info on this in chapter 12.

5.2.5. Programming

Where intended, LokPilot decoders support all programming modes including POM (Programming-On-the-Main). You can use any NMRA-DCC compatible command station for this purpose.

Even with the Märklin® central units 6020®, 6021®, Mobile Station® and Central Station® all settings are adjusted electronically. Most LokPilot V4.0 decoders support a simple-to-use programming procedure.

Owners of the ESU ECoS enjoy an even more comfortable method of programming: you can read all possible settings in plain text on the large display and easily adjust them – even during operation!

5.2.6. Operational Reliability

LokPilot decoders store the current operating status. Thanks to this data storage, the decoder will start again as quickly as possible after a service interruption. Some decoders also have an integral „PowerPack“ that assures continuous power even in case of poor electrical contact.

5.2.7. Protection

All function outputs as well as the motor output have protection against overload and short circuit. We want you to enjoy your LokPilot decoders for a long time.

5.2.8. Future built-in

All LokPilot V4.0 decoders are suitable for firmware updates due to the flash memory. You may add new software functions at a later stage.

Installing the Decoder

6. Installing the Decoder

6.1. Requirements for Installation

The locomotive must be in perfect operating condition prior to the conversion: Only a locomotive with faultless mechanical properties and smooth running characteristics in analogue mode is worth converting to digital. Check and replace all wear and tear parts such as motor brushes, wheel contacts, light bulbs etc., if necessary.



Please take note of the remarks in chapter 3 in order to prevent possible damage of the decoder during installation!

6.2. Installing the Decoder

The components on the decoder must under no circumstances touch any metal parts of the locomotive since this could lead to short circuits and damage or even destruction of the decoder. Therefore, all LokPilot decoders (with the exception of the ones with the 21MTC-interface) come with a protective shrink sleeve.



Never wrap the decoder in insulating tape. If there is no ventilation around the decoder, it may lead to a heat build-up and ultimately to the destruction of the decoder. Rather apply the insulating tape to the metal parts of the locomotive.

Mount the decoder at a suitable location. In most model locomotives, there is a dedicated space for the decoder. To hold the decoder in place use double sided adhesive tape or some (just a little) hot glue.

6.3. Locomotives with 8-pin NEM 652-Interface

Some LokPilot V4.0 decoders are supplied with an 8-pin interface as per NEM 652 (refer to Fig 1). Installation in locomotives with this interface is particularly easy:

- Remove the locomotive body. Please observe the instructions in the manual of your locomotive!
- Remove the dummy plug from the socket and keep it in a suitable place for later use.

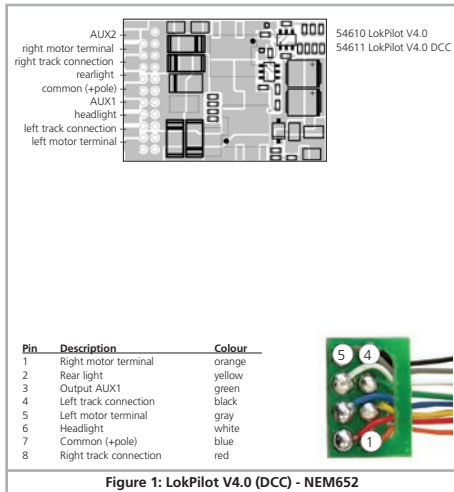

- Insert the plug of the decoder in such a way that pin 1 of the plug (this is the side with the red / orange wires) sits next to the corner of the socket that is usually marked with *, +, • or 1. Please make sure that the pins are straight when inserting the plug.



Do not rely on the assumption that the wires of the harness have to face in a certain direction: the only reliable reference is the marking of pin 1.

Installing the Decoder

6.4. Locomotives with 6-pin NEM 651-Interface

Some LokPilot V4.0 decoders have a 6-pin NEM 651 plug (as per

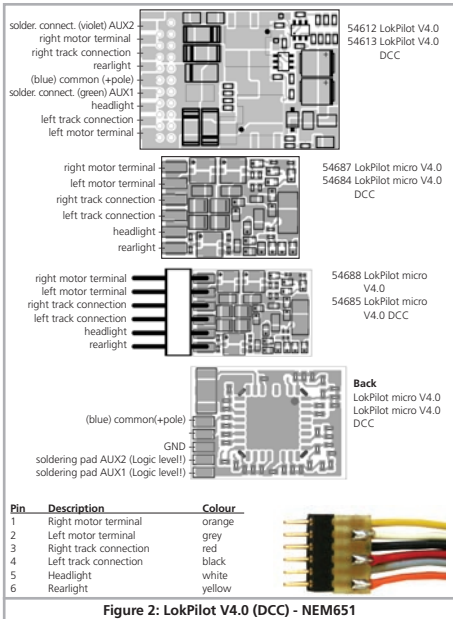
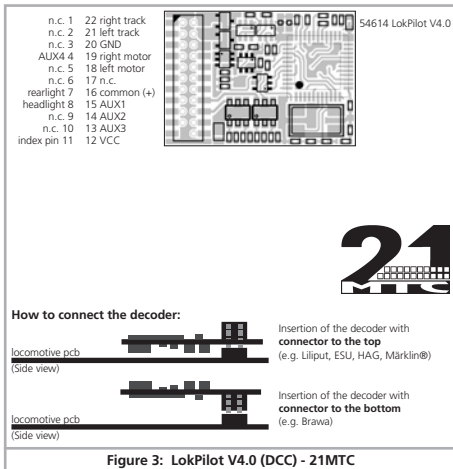

Fig. 2). Installation in locomotives with this interface is particularly easy:

- Remove the locomotive body.
- Remove the dummy plug from the socket and keep it in a suitable place for later use
- Insert the plug of the decoder in such a way that pin 1 of the plug (this is the side with the red / orange wires) sits next to the corner of the socket that is usually marked with *, +, ● or 1. Please make sure that the pins are straight when inserting the plug.



Installing the Decoder

6.5. Locomotives with 21MTC Interface

Some LokPilot decoders are available with a variant of the 21MTC interface as per Fig. 3. Installation in locomotives with this interface is particularly easy since the plug-socket connector facilitates the mechanical fixing as well.

- Remove the locomotive body. Please observe the instructions in the manual of your locomotive!
- Remove the dummy plug from the socket and keep it in a suitable place for later use
- Search for the missing pin in the plug on the circuit board of the locomotive. The missing pin serves as the marker. Memorise its location.
- You can insert the decoder in two ways: either the pins are put through the decoder; the socket of the decoder remains visible after installation (mounting on top) or the decoder is inserted in such a way that the pins go straight into the socket. Once the decoder sits in the socket, the socket is hidden from view. This method is common for Brawa locomotives.
- Which of the two mounting positions is the correct one depends solely on the locomotive. The position of the marker-pin is the crucial indicator.
- Plug the decoder into the socket in such a way that the locomotive interface corresponds with the decoder.
- Do not apply too much pressure when inserting the plug. The decoder must go in without force.
- Check if the decoder sits correctly.

6.5.1. Connecting C-Sine motors („SoftDrive-Sinus“)

The LokPilot decoder cannot drive the newer Märklin® models with C-Sine motors (also called „SoftDrive-Sinus“) directly. To facilitate this, a circuit board supplied with the locomotive is required. Märklin® uses the 21MTC interface installed on this circuit board and thus utilises the normal motor commands from the decoder for the exchange of information.

The LokPilot V4.0 with the 21MTC interface is suitable for controlling the C-Sine control electronics provided some parameters are set accordingly. Chapter 11.5. explains the necessary steps.



Some Trix® locomotives have the same C-Sine motor; however, the control electronics in Trix® locomotives communicate in a different manner with the decoder.

All of the LokPilot V4.0 decoders send the necessary commands to ensure that the respective locomotives work with the decoder. Unfortunately Trix® changed the interface too often in the past, therefore we are not able to guarantee you a proper function. In case of doubt, trying might just help.



The serial protocol can be switched on with the help of CV 124, Bit 3.

6.6. Locomotives with PluX Interface

Some LokPilot decoders are shipped with a 12-pin PluX12 interface according to NEM658. These decoders can be installed in a locomotive which comes with a PluX16 or PluX22 interface. More information about how to install the decoder is given in chapter 6.3.

6.7. Locomotives without Interface

All LokPilot decoders have an interface (plug). There is no „wires-only“ version. Please remove the plug at the end of the harness should this become necessary.



Please do not extend any wires at the decoder end. If necessary use an extension harness (also refer to chapter 17).

Wiring Diagram for LokPilot

6.7.1. Wiring Diagram for LokPilot

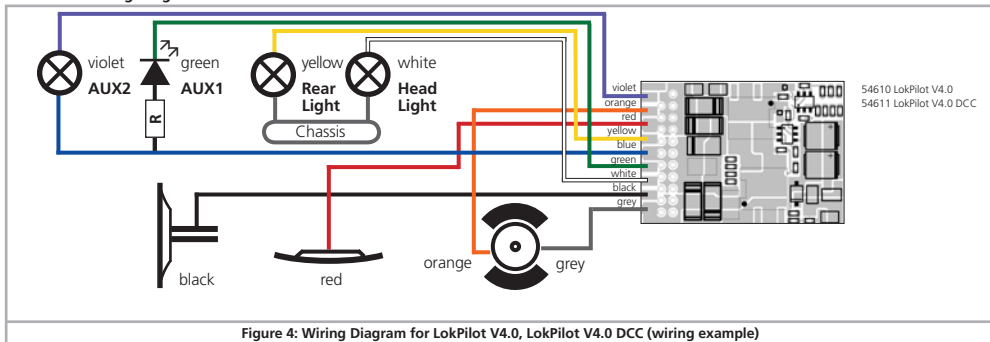



Installing the Decoder

6.7.3. Colour Coding by Märklin®

Märklin® uses a different colour coding system compared to the DCC colours. Please refer to fig. 8 for more information.

6.7.4. Motor and Track Connections

Firstly, please cut all wires installed in the locomotive. Take special care to remove any connections to the chassis: the motor leads must be positively potential-free, in other words they may not have any contact to the chassis or body or the wheels and wheel contacts. It is particularly easy to overlook such connections in Fleischmann® locomotives.

Make notes of which motor lead connects the motor with the right and the left wheel contact.

This avoids mistakes and assures that your locomotive runs in the right direction.



Please check all connections with an Ohmmeter. Search for short circuits, particularly between the motor leads and the wheel contacts.

- Connect the red wire to the right rail pickup or the centre pick up in AC models.
- Connect the black wire to the left rail pickup or the chassis in AC models.
- Connect the orange wire with the motor terminal, which originally lead to the right wheel pick up (centre pick up in AC models).
- The grey wire goes to the terminal, which originally connected to the left rail (chassis for AC models).

6.7.4.1. Connecting DC and Coreless Motors

You may use all DC motors commonly used for model trains provided they do not exceed the current limit of the decoder.

In some cases with the 5-pole High Performance Drive by Märklin®, you may find three anti-interference capacitors.

The two capacitors connected directly to the motor leads and the motor housing **MUST** be removed (also refer to Fig. 9 on the following page).

Description	Märklin® colour	ESU colour (according to NMRA DCC standard)
AC: Power pick up show («Schleifer») (Center rail)	red	red
DC: Right track connection		
AC: Outside rails	brown	black
DC: Left track connection		
Left motor terminal	blue	orange
Right motor terminal	green	grey
Common (rectified track voltage) (+Pole) for function outputs	orange	blue
Function output rear lights	yellow	yellow
Function output head lights	grey	white
Function output AUX1	brown/red	green
Function output AUX2	brown/green	violet
Function output AUX3	brown/yellow	-
Function output AUX4	brown/white	-

Figure 8: Colour coding by Märklin® in contrast to the DCC wiring code

Installing the Decoder

6.7.4.2. Connecting Universal Motors with HAMO-Conversions

Do not wire universal motors installed in many older Märklin® locomotives (also known as AC motors) directly to LokPilot decoders. You must modify the motor by first installing permanent magnets – so called HAMO magnets. You may purchase these magnets from your ESU dealer.

We supply three types of magnets. Please refer to chapter 18.2. for more information regarding motor conversions with permanent magnets.

6.8. Connecting Additional Functions

You can wire any kind of load such as light bulbs, LEDs (light emitting diodes), smoke generators or similar devices to the function outputs provided the maximum current draw is less than that of the decoder output.

 The permitted maximum current draw per function output is listed in chapter 20 under „Technical Data.“

 Please make sure that the load does not exceed the permitted maximum current and there are no short circuits. The outputs of the LokPilot have protection but if an external voltage is applied, the outputs may suffer damage or destruction.

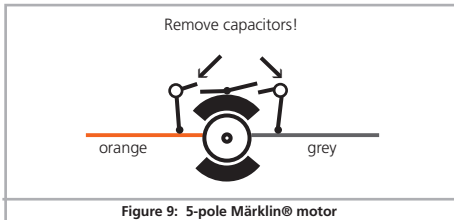



6.8.1. Overload Protection of Function Outputs (Blinking)

The function outputs of LokPilot decoders have electronic protection against overload and short circuit. The decoder keeps checking the sum of all function output currents. If the current is too high, the decoder will switch off the outputs. After about 1 second, the decoder tries to switch them on again. Should the current still be too high – perhaps due to a short circuit – the same procedure starts again.

When using light bulbs (incandescent lamps) please note the following: they draw a very high „inrush current“ when they are switched on, that becomes lower after a few moments. Therefore, it can happen with 12V bulbs that the headlights „flash“ briefly during switch-on and then extinguish due to the overload protection of the decoder. The lights will be shortly switched on and off again in a one-second cycle. This results from a much too high inrush current of the bulbs; the decoder is not able to distinguish between the bulbs' high inrush current and an overload. Therefore it is important to install the correct bulbs.

6.8.1.1. Suitable Light Bulbs

 Only install bulbs rated 16V or higher and with a nominal current draw, that does not exceed 50 mA.

 Many older models by ROCO® and Fleischmann® have 12V bulbs installed. They draw a high current, become very hot, and may cause damage to the locomotive. Replace them with 16V bulbs.

6.8.2. Connecting the Light Outputs as well as AUX1 and AUX2

This procedure depends on the wiring of the lights and auxiliary functions in the locomotive:

- The lamps / function outputs are insulated from the common pole (ground) (i.e.: the locomotive chassis); therefore they are potential free. Fig. 4 shows the correct wiring for the outputs AUX1 and AUX2. The functions of the locomotive must be potential-free, in other words there may not be any other connection to the function besides the wires from the decoder. The voltage at these outputs is about 1.5V lower than the track voltage. The blue wire is the „plus-pole“; the function output the „minus-pole.“

Installing the Decoder

If LEDs are installed (also refer to Fig. 4, output AUX1), then a resistor must be wired in series with the LEDs. It should have a rating of between 470 Ohms and 2.2 kOhms. Running the LEDs without this resistor will lead to their destruction!

b) The lamps / function outputs are wired (together) against the chassis of the locomotive (as in most locomotives by Märklin® as well as in most older locomotives by Fleischmann® and ROCO®).

This scenario is illustrated for the light outputs in Fig. 4 (the headlights can of course also be wired as in „a) above“. The wiring is simpler but the available voltage is about half.



This type of connection is not suitable for multi-protocol operation. Both M4 and Motorola® packets are asymmetrical. Therefore, the function outputs do not have continuous power. This leads to a rhythmic flicker of the headlights (pulsing) that becomes particularly obvious with LEDs. Furthermore, the headlights will only work in one direction in analogue DC mode. Whether it will be the forward lights or the backup lights depends on which way you have placed your locomotive on the track.

- Solder the backup lights to the yellow wire, the headlights to the white one.
 - The green wire connects to the function output AUX1.
 - The violet wire goes to the function output AUX2.
- If your locomotive is wired according to option b), then it is ready for use. Otherwise, you must connect the remaining wires of all bulbs and functions together to the blue wire. This pole may not have any connection to the chassis!



As shown in Fig. 4 it is possible to use both options in the same locomotive.

6.8.3. Purpose of AUX3 and AUX4

6.8.3.1. LokPilot with 21MTC Interface

LokPilot decoders with 21MTC interface have two additional outputs besides the 4 standard outputs, namely AUX3 and AUX4. Since they are pure „logic-outputs,“ it is not possible to connect any external loads directly. External power transistors are required. Connect AUX3 and AUX4 via the interface; there are no wire leads. In terms of their functionality, AUX3 and AUX4 are equal to the other outputs. ESU offers an appropriate adapter board (art. no. 51968) with transistors.

6.8.4. Suitable Smoke Generators

Unfortunately, it is not an easy task to find the right smoke generator for each locomotive. The amount of smoke generated depends on the following factors:

- a) Track voltage
The track voltage varies depending on the command station. Therefore, it is possible that a locomotive generates smoke when driven by one digital system but does not generate any smoke with another system. Even 1V variation makes a big difference.
- b) Type and tolerance of the Seuthe smoke generator and the smoke distillate
Seuthe smoke generators have considerable production tolerances. Therefore, it is possible that one unit works perfectly well while another does not. Type of distillate and filling level have an influence as well.
- c) Setting the decoder output
For correct smoking action you should set the AUX output to „Dimmer“ as well as full „Brightness.“ More info in chapter 12.
- d) Connecting the smoke generator
Most smoke generators are wired against the chassis. Therefore the smoke generator only receives current in every second half cycle. How much power gets to the smoke generator depends on your command station and the digital protocol.

Installing the Decoder

Generally, Seuthe type 11 is recommended, but it does not get enough power and therefore does not smoke satisfactorily.

There are two options on how to solve this problem:

Solution 1: Using the Seuthe No. 10. This type is intended for analogue operation and draws a relatively high current. Subject to its tolerance levels, it may trigger the overload protection of the decoder. In this case, you must wire a relay (ESU No. 51963) into the circuit or you slightly reduce the „Brightness“ of the output.

Solution 2: Using the Seuthe No. 11. Do not wire it against the chassis but rather use the blue wire for the second pole („U+“). This prevents the asymmetric track signal from interfering with the smoke generator. It represents the best solution but is sometimes a bit difficult in terms of wiring.

6.9. Connecting Capacitors

On many older layouts, current pick up of locomotives is not very reliable. Therefore, power interruptions may cause a stop or jerky movement when the locomotive travels over turnouts at low speeds. This can be overcome with buffer capacitors (100 μ F / 25V or higher show the desired results). If desired you may connect them to the LokPilot decoders.

 Soldering wires onto a decoder requires quality soldering equipment and experience. Our warranty does not cover damage caused by inappropriate soldering. Consider carefully if you really need that capacitor.

6.9.1. All LokPilot

You can connect two larger capacitors as per the circuit in the upper half of Fig. 10.

The capacitor is charged via a resistor (100 Ohms) thus preventing the digital system from interpreting the charging current as short circuit at the time of switch-on. The diode makes sure that the energy of the capacitor is fully available when required.



However, you may not run this locomotive on AC layouts anymore. Risk of destruction!



Disconnect / remove the capacitor prior to programming with the ESU LokProgrammer!

6.9.2. Optional "PowerPack"

You can solder a powerful energy buffer to all LokPilot V4.0 H0 decoders. In the lower half of Fig. 10 we show you how to do it. This „PowerPack“ allows your locomotive to keep running for 2 seconds without power.

- The PowerPack only operates in digital mode. It automatically turns off on analogue layouts.
- It may take up to two minutes to fully charge the capacitor („GoldCap“). Therefore, the time bridged with the energy buffer depends on the current draw of your locomotive and the charge-up time.
- Further information about how to use the PowerPack module is to be found in the "PowerPack module" manual.

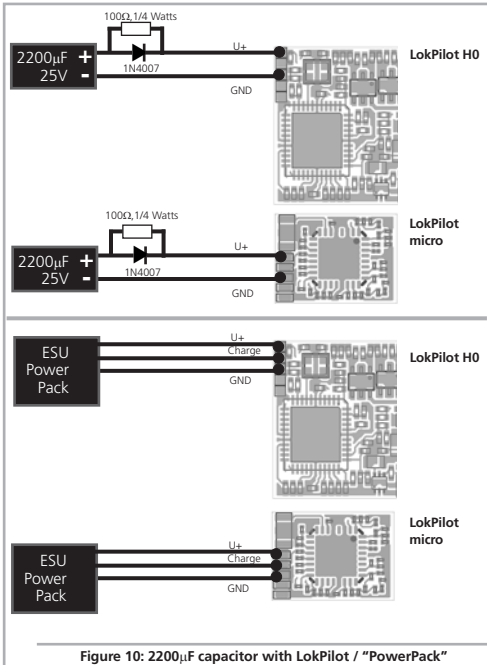

Figure 10: 2200µF capacitor with LokPilot / "PowerPack"

7. Initial Operation

7.1. Factory Default Values

The address is set to 03 with 14 speed steps.

LokPilot V4.0	LokPilot V4.0 DCC	

- F1 switches output AUX1.
- F2 switches output AUX2.
- F3 switches the shunting mode on and off.
- F4 switches the acceleration and deceleration on and off.

- Does the locomotive move in both directions?
- Does the indicated direction of travel correspond with the actual one? If not, are the motor leads swapped or is the 8-pin plug inserted the wrong way round?
- Switch on the lights: do they work properly? If you have installed a LokPilot with an 8-pin plug, check if the plug sits in the socket correctly.

7.2. Digital Operating Modes

In the following chapters, we describe the operation of the LokPilot with different digital systems.



Since not every LokPilot supports all digital systems, we state which chapter is applicable for which type.

7.2.1. DCC operation

LokPilot V4.0

LokPilot V4.0 DCC

LokPilot micro V4.0

LokPilot micro V4.0 DCC



Remove any capacitors that are wired into the track feeders (e.g. ROCO® feeder track). This could impair the functionality of the decoder.

The LokPilot works with any DCC system. Unfortunately, the DCC protocol also brings some difficulties into the game. One of them occurs so often that we deal with it right away.

7.2.1.1. DCC Speed Steps („flashing lights“)

„Lights do not work“ with DCC systems: DCC locomotives run with 14, 28, or 128 speed steps. The decoder offers all of the three options and needs to „know“ with which option the the command station operates the decoder. The command station must be able to operate with this mode and must be set accordingly. If this is not the case, the following problems may occur:

- You cannot switch the lights with F0 at all.
- The lights keep switching on and off dependent on the speed step. On and Off again, and On again, and Off again etc.

In this case, make sure that the speed step settings of decoder and command station are the same.

7.2.1.2. Auto-detection of DCC Speed Steps

LokPilot decoders implement auto-detection to avoid the above problem. We have tested this with the following systems:

- ESU ECoS®
- Bachmann E-Z-Command® Dynamis®
- ROCO® Lokmouse2 and Lokmouse3
- Uhlenbrock® Intellibox
- Lenz® Digital plus V2.3
- ZIMO® MX1



When operating with Lenz® digital plus V3.0 the auto-detect feature does not work at 14 speed steps. Select 28 / 128 speed steps instead.

The LokPilot tries to establish the speed step setting every time it receives power (i.e.: after switching on the power on your layout or the track sector where your locomotive is located) and the lights are switched on. This process requires that you switch on the lights and turn the throttle until the lights light up continuously.

Should you change the speed step setting during operation then you must interrupt the power to the decoder for a short moment in order to activate the auto-detection.

This auto-detect feature can be turned off with bit 4 in CV 49 (also refer to the CV table in chapter 21.1). Then you have to set the correct speed step with bit 1 in CV 29.

7.2.2. Motorola® Mode

LokPilot V4.0

LokPilot micro V4.0

The LokPilot works with all Märklin® devices and compatible systems that are in the market until now. The functions F1 to F4 can only be activated with the so-called „new Motorola® format.“ In order to activate this you must set the DIP-switch 2 on your 6021 to the upper position („On“).

LokPilot decoders support two special features in Motorola® mode:

7.2.2.1. 28 Speed Steps

While the original Motorola® system used by the following central units, namely Märklin® central unit 6021, Delta® and Mobile Station®, only supports 14 speed steps, the LokPilot decoder can also handle the 28-speed step mode. In conjunction with suitable command stations (e.g.: ESU ECoS, in „Motorola® 28“ mode) this leads to smoother control of your locomotives. No changes are required on the decoder.

7.2.2.2. Extended Motorola® Address Range

While the original Motorola® format only knows the addresses from 01 to 80, the LokPilot offers the following range of addresses:

LokPilot V4.0

01 - 255

Chapter 9 explains how to set the address.

7.2.3. Selectrix® Mode

LokPilot V4.0

LokPilot micro V4.0



You may operate the LokPilot with any Selectrix® compatible command station with access to the functions „lights“ and F1.

For programming any parameters, you must use the DCC programming mode. It is not possible to program it with a „pure“ Selectrix® system. Any changes programmed in DCC are also valid for operation with Selectrix® command stations.

As soon as a decoder receives commands in Motorola® or DCC format (whenever it receives a signal packet with information addressed to it), the Selectrix® receiver switches off automatically. This allows trouble-free mixed operation with Selectrix® / DCC / Motorola®. The Selectrix® receiver turns on again as soon as the decoder detects a power interruption.

Analogue Mode

7.3. Analogue Mode

All LokPilot decoders are set ex factory to operate in analogue mode as well.



Please take note of the remarks in chapter 10.4 if the decoder should move repeatedly from analogue into digital sectors and back.

7.3.1. Analogue DC operation

LokPilot V4.0

LokPilot V4.0 DCC

LokPilot micro V4.0

LokPilot micro V4.0 DCC

LokPilot decoders work on conventional DC layouts. From the factory, load compensation is active. This provides smooth control of your locomotives even at low speeds (in DC mode as well). Since load compensation requires about 3 – 4 Volts as „base voltage“ you must turn the throttle further than normal (=locomotives without decoder) before the locomotive starts moving.

7.3.2. Analogue AC Operation

LokPilot V4.0



Other LokPilot decoders than the ones mentioned above are not suitable for analogue AC mode. AC will definitely lead to the destruction of the decoder!

Where intended, LokPilot decoders support operation with AC transformers. Therefore, the LokPilot decoder can simply replace the old directional relay. Load compensation is active (similar to DC mode) and provides smooth control and slow-speed-performance you have never seen before. The LokPilot V4.0 recognised the

pulse for changing direction as usual. Just wait until the locomotive has stopped prior to changing direction.



Never issue the „Change of Direction“ command to a moving locomotive! This could lead to damaged gears!



We cannot recommend the use of the old (blue) Märklin® transformers that were originally designed for 220 Volt. Depending on their age and their tolerance range, the pulse for changing direction could be too high in case of increased mains voltage and therefore destroy the LokPilot decoder.

Do yourself and your locomotives a favour and purchase a suitable Märklin® transformer No. 6647 – your locomotives and decoders will thank you with longer product life!

8. Decoder Settings (Programming)

Chapter 8 covers setting various parameters of the LokPilot decoder. Should you not be familiar with the handling of CVs please take the time to read these occasionally quite complex instructions.

After an introduction into the world of parameters in chapter 8.1, we explain in the following section 8.2 how to change various parameters in DCC mode and with Märklin® central units.

The chapters 9 to 16 explain which parameters have what kind of influence on the behaviour of the LokPilot decoder.

8.1. Adjustable Properties of Decoders

The hardware determines some features such as the number of function outputs as well as the maximum permitted current of the motor output and therefore they are not programmable. Nevertheless, there are plenty of possibilities to influence the behaviour of the LokPilot decoder by adjusting software-governed properties.

There is at least one memory space within the decoder reserved for each adjustable parameter where numbers or letters can be stored.

You could visualize the storage spaces as index cards in a large file box. In order to enable you to find the right card again, they all have numbers and / or names outlining the properties of this particular card such as „locomotive address“ or „maximum speed.“

Then imagine that you can write information onto these cards. Adjusting the settings means nothing else but erasing one entry and replacing it with another. Moreover, you could do that at any time. However, you cannot write onto every card: some bits of information like the manufacturer's code are firmly encoded.

Thus, you can determine the content of the storage spaces in the decoder even during operation and of course, the decoder will follow the instructions. Via the procedure known as „Programming,“ you can enter the desired data into the storage spaces.

8.1.1. Configuration Variables (CVs)

LokPilot V4.0	LokPilot V4.0 DCC	
LokPilot micro V4.0	LokPilot micro V4.0 DCC	

LokPilot decoders follow the CV concept developed in the US. CV stands for „Configuration Variable“ and indicates that the storage cells described above are not only variable but they also determine the behaviour of the decoder.

8.1.1.1. Standardisation in the NMRA

The NMRA (National Model Railroad Association) has defined which CVs determine certain parameters of a decoder. The DCC standard allocates fixed numbers for certain CVs (adherence is obligatory). This greatly simplifies things for the user since decoders of most manufacturers comply with this standard and therefore dealing with CVs requires the same process with the same CV-numbers regardless of the manufacturer.

The DCC concept permits to enter numbers ranging from 0 to 255 into CVs. Each CV carries only one number.



While the position number is predetermined, the range of values may vary. Not all CVs must accept values ranging from 0 to 255.

The permitted values for LokPilot decoders are listed in the table in chapter 20.1. showing all available CVs.

8.1.1.2. Bits and Bytes

Most CVs contain numbers: CV 1 for instance contains the locomotive address. This can be any number between 1 and 127. While most CVs expect numbers to be entered, some others are rather like a „collection point“ of various „switches“, that administer different functions in one CV (mainly „on“ or „off“): CVs 29 and 49 are good examples: you must calculate the value for these CVs yourself. The value depends on which settings you want to program:

Have a look at the explanations for CV 29 in the table in chapter 20.1.: firstly, decide which options should be active. The column „Value“ has two numbers for each option. If the option is switched off, the value is 0. Otherwise, it is a number between 1 and 128. Add all the values for the respective options to arrive at the correct value for this CV.

Example: Let us assume you want to run trains with the ECoS in DCC mode with 128 speed steps. Analogue detection should be active (because you also want to drive your locomotive in analogue mode). All other options are not active.

Therefore, you must write the value 6 in CV 29 ($0 + 2 + 4 + 0 = 6$).

8.2. Programming with popular Digital Systems

As already explained it is not possible to program every type of LokPilot with every command station in the market. This chapter explains which options are available.

8.2.1. Programming with DCC Systems

LokPilot V4.0

LokPilot V4.0 DCC

LokPilot micro V4.0

LokPilot micro V4.0 DCC

LokPilot decoders support all NMRA programming modes as there are the programming track modes (Direct Mode, Register Mode, Paged Mode) and the mode for the main („POM“, „Programming on the Main“).

Programming on the Main enables you to program your decoders comfortably without having to remove the locomotive from the layout. In this case, the command station talks directly to the decoder by using its locomotive address, for instance: „Locomotive number 50, write the value 7 into CV 3!“. Thus knowing the locomotive address is a precondition. Unfortunately, you cannot read CV values.

i However, with RailCom® you can read CV values on the main. More on this topic in chapter 15.

Assuming you have a suitable DCC system you can read CV values on the programming track. You can also reprogram the locomotive address without knowing the old address since the command station simply transmits the command „Write value 7 in CV 3!“. Each decoder receiving this command will execute it.

i ESU counts the bits from 0 to 7 as laid out in the standards while others (e.g.: Lenz) count the bits from 1 to 8.

8.2.2. Programming with the ESU ECoS

LokPilot V4.0

LokPilot V4.0 DCC

LokPilot micro V4.0

LokPilot micro V4.0 DCC

The owners of an ESU ECoS can comfortably program LokPilot decoders. ECoS has a library of „Decoder Profiles“ that help you

to program decoders with the graphic display. All CVs are stored in the decoder profile thus enabling the ECoS to read them and to display them on the screen. Chapter 16.5. of the ECoS manual provides more information on this topic.

i Please make sure that you always use the latest ECoS firmware version. Whenever we expand the range of the LokPilot family, only an update will add the required decoder profile.

8.2.3. Programming with Märklin® 6021

LokPilot V4.0

LokPilot micro V4.0

The Märklin® central unit 6021 works differently: Since it does not comply with the NMRA DCC standards, LokPilot decoders start a special, obligatory programming procedure. Reading of values is not permitted.

There are two modes:

In the short mode parameters with a number below 80 can be set provided the desired value is also lower than 80.

In the long mode, all parameters with values from 0 to 255 are adjustable. Since the display of the 6020 /6021 is limited to two-digit numbers, values must be split and entered in two separate steps.

8.2.3.1. Changing the Programming Mode

Enter the programming mode with the 6020/6021:

The throttle must be set to „0“. No other locomotives may be on the layout. Watch out for flashing signals of the locomotive!

- Press the „Stop“ and „Go“ buttons of the 6021 simultaneously until a reset has been triggered (alternately pull the mains plug of the transformer). Press the „Stop“ button in order to switch off the track voltage. Enter the current decoder address. If you do not know the current address, simply enter „80“.
- Activate the change-of-direction button (turn the throttle knob to the left beyond the arrester until you hear a click sound), hold it in this position and then press the „Go“ button.



Please bear in mind that the 6020/6021 only permits you to enter values from 1 to 80. The value 0 is missing. lways enter „80“ instead of „0“.

8.2.3.2. The Short Mode

The decoder is in the short mode (the headlights flash periodically in brief intervals).

- Now enter the number of the CV that you want to adjust e.g.: „01“. Always enter this number with two digits.
- For confirmation activate the change-of-direction routine (now the lights flash twice very quickly).
- Now enter the new value for the desired CV, e.g.: 15 (two digits).
- For confirmation activate the change-of-direction routine (now the lights light up for about one second).
- Then you can enter other CVs as desired.
- Selecting „80“ allows you to exit the programming mode. Alternately you can switch off the track voltage and then on again (press the „Stop“ button on the 6021, then the „Go“ button).

8.2.3.3. Long mode

You access the long mode by entering the value 07 in CV 07 while in the short mode. The decoder confirms the change to the long mode by slowly flashing lights.

- Enter the hundred-digit and the ten-digit (decade) of the CV that you want to change. Example: If you want to adjust CV 124, you enter „12“.
- For confirmation activate the change-of-direction routine (now the lights flash periodically: long – short – long – short - etc.)
- Now enter the unit of the CV („04“ in this example).
- ⚠️ For confirmation activate the change-of-direction routine. Now the decoder expects the entry of the CV value. The lights flash periodically: long – short – short).
- Now enter the hundred-digit and the ten-digit (decade) of the new CV value (as a two-digit number). Example: You want to write the value 135. Therefore, you enter „13“.
- For confirmation activate the change-of-direction routine. Now the lights flash periodically: long – short – short – short).
- Now enter the unit of the new CV value as a two-digit number („05“ in this example).
- For confirmation activate the change-of-direction routine (now the lights light up for about one second).
- Now you can adjust more CVs in long mode.
- Exit the long mode by switching off the track voltage and then on again (press the „Stop“ button on the 6021, then the „Go“ button).

8.2.4. Programming with the Märklin® Mobile Station®

LokPilot V4.0

LokPilot micro V4.0

With the Mobile Station®, you can also adjust some of the CVs. Use the Register Programming Menu to facilitate this.



As with the 6021, you can only enter values between 1 and 80. The possible CV values are also limited to that range from 1 to 80.

You will find the programming menu in the locomotive menu of the Mobile Station®. It is only available for certain locomotives. Of course, this works only for a programmable locomotive.

Proceed as follows:

- Enter a new locomotive in the database. How you do this is explained in the manual for the Mobile Station®.
- Select locomotive 36330. The locomotive Ex 3/3 is shown as active on the display.
- By pressing the „MENU / ESC“ button you can now change any of the settings such as name, address, etc. in the heading „CHANGE LOCOMOTIVE“. The last function shown is „Register Programming“ (REG). Select this for writing CVs.
- Then select the CV (called „REG“ on the Mobile Station®) and then the desired value and confirm by pressing the change-of-direction button.
- The Mobile Station® will program the new value into the decoder.



Please remove all other locomotives prior to programming!

8.2.5. Programming with the Märklin® Central Station

LokPilot V4.0

LokPilot micro V4.0

With the Central Station®, you can program the CVs 1 to 80 via the Motorola® programming menu. Unfortunately, you can only enter values between 1 and 80.

Find more information regarding this programming mode in chapter 8 of the manual of the Central Station®.

8.2.6. Programming with the ESU LokProgrammer

LokPilot V4.0

LokPilot V4.0 DCC

LokPilot micro V4.0

LokPilot micro V4.0 DCC

The LokProgrammer 53451 offers the easiest and most comfortable way of setting the CVs of LokPilot decoders: simply by a few mouse clicks on an MS-Windows® computer. The computer saves you to look for the various CV numbers and values. More information is contained in the manual for the LokProgrammer.

You can access all properties of ESU decoders with the LokProgrammer. Since this works independently from the data format it also works for mfx® decoders.



Please use the software version from V4.0 onwards for the LokPilot V4.0 decoder. The software is available for download on our website.

9. Address Settings

Each LokPilot decoder requires a definite address to be addressable for the central unit. Depending on the type of decoder and the digital system, there are several possibilities how to allocate addresses.

9.1. Short Addresses in DCC Mode

LokPilot V4.0	LokPilot V4.0 DCC	
LokPilot micro V4.0	LokPilot micro V4.0 DCC	

Normally you would control LokPilot decoders with the short address that is stored in CV 1. In DCC mode, the permitted values range from 1 to 127. In order to enable the decoder to „listen“ to the short address you must delete bit 5 in CV 29.



Some digital systems (e.g. ROCO® Lokmouse2, Lenz® digital plus, Lenz® compact) only support the values 1 – 99 as short address.

9.2. Long Addresses in DCC Mode

LokPilot V4.0	LokPilot V4.0 DCC	
LokPilot micro V4.0	LokPilot micro V4.0 DCC	

You can operate LokPilot decoders also with long addresses (4-digit addresses). The supported values range from 128 – 10239. The long address is stored in the CVs 17 and 18. You must activate the long address by setting bit 5 in CV 29.



Bit 5 in CV 29 switches between short and long address. The decoder can only respond to one address at a time.

If you want to use your LokPilot with the long address it is practical to program this address directly with your digital system: most modern digital systems (e.g. ESU ECoS, Bachmann E-Z Command® Dynamis®) have a menu for programming long address-

es. The command station not only programs CV 29 correctly but also assures the correct storage of the values for the long address in CV 17 and 18.

If you want to enter the long address manually in CV 17 and 18 please refer to chapter 22.1.

9.3. Motorola® Address

You can also operate many LokPilot decoders with the Motorola® format. The address for this operating mode is stored in CV 1.

LokPilot V4.0		
LokPilot micro V4.0		

This address is identical to the short address in DCC mode as described in chapter 9.1. The LokPilot decoder responds both to commands in DCC and in Motorola® mode at the same time. The permitted values are listed in chapter 7.2.2.2.



Märklin® digital devices (6020, 6021, Delta®) can only work with addresses from 1 to 80. Should you have entered a higher value in CV 1 you will not be able to drive this locomotive with these central units.

Adapting the Driving Characteristics

10. Adapting the Driving Characteristics

10.1. Acceleration and Deceleration

Acceleration and brake time can be set independently from each other. Therefore, you could for instance program a short acceleration and a much longer brake time.

The time for accelerating is adjusted in CV 3 while deceleration is set in CV 4. Permitted values are 0 (no delay) to 63.

The times set in these CVs work speed dependant. Therefore, the acceleration distance and the brake distance are longer at high speeds. In other words, the faster the locomotive moves, the longer is the distance until it stops.



For information on how to set a brake distance independently of the speed refer to chapter 10.6.

10.1.1. Switching Acceleration / Deceleration

LokPilot decoders can deactivate acceleration and deceleration by the push of a button. This is particularly handy for shunting since your locomotive responds directly to the throttle.

The default setting for this function is function button F4.

10.1.2. Shunting Mode

The default setting for the shunting mode is F3. It reduces the speed to about 50%. Thus, you have smoother control of your locomotive in the lower speed ranges, which is important for shunting, particularly in the 14-speed-step mode.

10.2. Starting Voltage, Maximum and Medium Speed

LokPilot V4.0

LokPilot V4.0 DCC

LokPilot micro V4.0

LokPilot micro V4.0 DCC

LokPilot decoders know internally 256 speed steps. They can be adapted to the characteristic of the locomotive and allocated to the actually available speed steps (14, 28, or 128).

The NMRA defined two options to facilitate this:

Motor characteristic via CV 2, 5, and 6 (Fig. 11): Enter the start voltage in CV 2 and the maximum speed in CV 5. CV 6 corresponds with the speed at a medium speed step. Thus, you can define a "kink" in the speed curve. This mode is active if bit 4 = 0 in CV 29.



The values of the start, mid and maximum speed are dependent on each other. Selecting a mid speed that is lower than the start speed or higher than the maximum speed could lead to some erratic driving performance. Therefore always adhere to the principle: start voltage < mid speed < maximum speed.

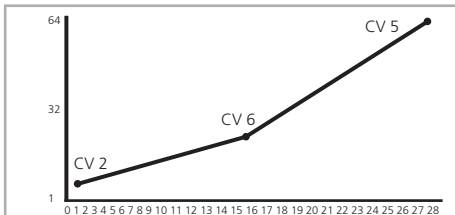

Figure 11: Speed settings using CV 2, 5, 6

10.3. Speed Curve

LokPilot V4.0	LokPilot V4.0 DCC	
LokPilot micro V4.0	LokPilot micro V4.0 DCC	

You may also define your own speed curve: simply enter the desired values in the CVs 67 to 94 (also refer to Fig. 12). The decoder will superimpose these 28 values onto the real speed steps. Thus, you can adapt the driving performance optimally to your locomotive. This mode is only active if bit 4 in CV 29 is set.

We recommend using the ESU LokProgrammer for easy and comfortable programming.



When this mode is active, the settings in CV 2, CV 5, and CV 6 have no influence.

10.4. Changing between Operating Modes

You may change from a digital to an analogue sector of your layout „on-the-fly“ at any time.

The locomotive behaves as follows:

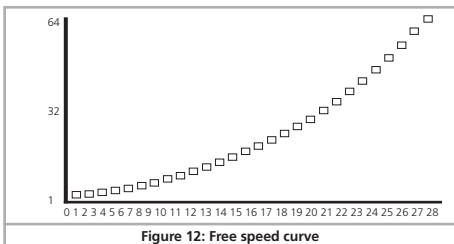

Figure 12: Free speed curve

10.4.1. Changing from Digital to Analogue DC

When the decoder enters the analogue DC sector, it monitors the polarity of the track voltage. If the polarity (and the resulting direction of travel as per NEM) matches the direction of travel in digital mode the locomotive will continue without stopping at the speed that corresponds to the analogue voltage.

If the polarity does not match then the behaviour depends on the settings in CV 27:

If the DC brake mode is active in CV 27 then the locomotive will slow down to a stop with the programmed deceleration, if not, then the locomotive will change the direction and back out of the analogue sector. Chapter 10.5 provides detailed info about brake sectors and the appropriate settings.

10.4.2. Changing from Digital to Analogue AC

If a locomotive travels into an analogue AC sector, it will continue onwards in the same direction at a speed corresponding to the analogue track voltage.

10.4.3. Changing from Analogue to Digital (directional bit)

When entering the digital sector the locomotive compares the current direction of movement with the digital signals arriving via the track: If the actual direction matches the one as per the digital signal, the locomotive continues onwards at a speed corresponding with the digital signals.

Does the direction not match the commands from the digital system, then the behaviour depends on the settings in the „directional bit“ (also refer to chapter 14.1. for more details):

If the directional bit has been set, then the decoder ignores the directional commands from the central unit, the locomotive continues in the same direction; only the speed will be adjusted according to the commands from the central unit. Therefore, the actual direction of movement does not match the direction as intended by the central unit for the time being; however, this changes once a change-of-direction-command is activated at the central unit.

If the directional bit has not been set, then the locomotive slows down and stops according to the programmed deceleration,

Adapting the Driving Characteristics

changes its direction and returns to the conventional sector. What happens next is described in chapter 10.4.1 resp. 10.4.2.

10.4.4. Changing from Digital to Digital

LokPilot V4.0

LokPilot micro V4.0

Travelling between sectors with different digital protocols, namely Motorola® and DCC is possible at any time. The LokPilot decoder interprets each valid data package from the command station.

LokPilot V4.0

LokPilot micro V4.0

Travelling from Selectrix® to DCC or Motorola® is only possible after a short power interruption (also refer to chapter 7.2.3).

10.4.5. Changing modes with Analogue Mode turned off

LokPilot V4.0

LokPilot V4.0 DCC

LokPilot micro V4.0

LokPilot micro V4.0 DCC

Perhaps you have disabled analogue mode on your decoder (bit 2 in CV 29 is deleted). When the locomotive moves from the digital sector into the analogue one, the locomotive will continue with the set speed and direction. However, you cannot issue any commands to that locomotive until it is back in a digital sector.

Under certain circumstances, the decoder interprets the analogue DC voltage as brake sector and slows down to a stop; please refer to chapter 10.5.

10.5. Brake Sectors

Brake sectors have the purpose to slow down the locomotive independently from the commands issued by the command station. Frequently, this function serves for stopping a train in front of a red signal. If a LokPilot detects a brake command, it will slow down with the programmed deceleration and then stop. After this enforced stop, the locomotive will accelerate again as per the programmed values in CV 3.

Depending on the type of digital system, there are several options on how to influence the decoder so that it stops the train.

10.5.1. DC Brake Mode

LokPilot V4.0

LokPilot V4.0 DCC

LokPilot micro V4.0

LokPilot micro V4.0 DCC

In order to activate the DC brake mode you must set bit 3 in CV 27. The LokPilot decoder will start brake once it moves from a digital sector into a DC sector provided the brake mode is active and the polarity of the track voltage does NOT match the current direction of travel. The locomotive will stop taking into account the programmed deceleration.

10.5.2. Märklin® Brake Mode

LokPilot V4.0

LokPilot micro V4.0

In principle, the Märklin® modules 72441 / 72442 apply a DC voltage to the track instead of the digital signals. Provided bit 3 and bit 4 in CV 27 is set, then LokPilot decoders detect this voltage and will stop the train (CV 27 = Value 24).



The signal generated by these modules looks the same as DC from conventional DC-transformers. The LokPilot could possibly misin-



terpret this and switch to the analogue mode instead of brake.
If you wish to control the LokPilot decoder with DCC signals and keep your Märklin® brake sectors then you should switch off the DC analogue mode by deleting bit 1 in CV 50. The LokPilot will stop as desired.

10.5.3. Selectrix® Diode Brake Sector

LokPilot V4.0		
---------------	--	--

LokPilot micro V4.0		
---------------------	--	--

LokPilot decoders also detect the Selectrix®-diode brake sector and stop as desired.

10.5.4. Lenz® ABC Brake Mode

LokPilot V4.0	LokPilot V4.0 DCC	
---------------	-------------------	--

LokPilot micro V4.0	LokPilot micro V4.0 DCC	
---------------------	-------------------------	--

As a new function the LokPilot V4.0 decoder supports the ABC braking technique introduced by Lenz®. In order to use this function a group of anti-parallel diodes will be soldered to one half of the track. The resulting fall of voltage generates an asymmetrical DCC signal. LokPilot decoders are able to detect the potential difference between the left and right half of the signal. If desired, the decoder will be stopped.

To be able to use the ABC technique you also need, beside the adequate LokPilot V4.0 decoder, an appropriate brake module. The ABC technique can only be operated with boosters offering an exact symmetrical output. All command stations and boosters by ESU and Lenz® guarantee a symmetrical output. We do not recommend the use of other booster for the ABC technique!

- If you wish to stop the LokPilot decoder when the track signal is stronger on the right side than on the left side (and the diodes are also installed on the left side), set bit 0 in CV 27.
- If you wish to stop the LokPilot decoder when the track signal is stronger on the left side than on the right side (and the diodes are also installed on the right side), set bit 1 in CV 27.
- If you want to stop the decoder no matter in which half of the track the diodes are set, please set bit 0 and bit 1 in CV 27 (CV 27 = 3).

10.6. Constant Brake Distance

LokPilot V4.0	LokPilot V4.0 DCC	
---------------	-------------------	--

LokPilot micro V4.0	LokPilot micro V4.0 DCC	
---------------------	-------------------------	--

An attractive function hides behind CV 254 (ESU brake mode): Here you can set a constant distance for braking the train, from the beginning of the brake sector to the stopping point. Thus, it is possible to stop the train right in front of a red signal regardless of the speed. The LokPilot simply calculates the required brake effect.

The higher the value in CV 254, the longer is the brake distance. Simply make some trials on a test track in order to find the values best suited to your locomotive.

If CV 254 is set to 0, then the normal time mode as per chapter 10.1. will automatically turn on.

The constant brake distance is only active in brake sectors. When you turn the throttle back to 0, the locomotive will slow down as per the value in CV 4.

Via CV253 you can choose how the LokPilot should decelerate.

Adapting the Driving Characteristics

10.6.1. Linear Braking Distance

CV253=0: The loco starts immediately to stop linearly after receiving the braking command. The brake effort is determined by the decoder so that, independent from the starting speed, the loco will stop after reaching the way defined in CV254. The dashed line in Figure 13 shows the relation.

10.6.2. Constant Linear Braking Distance

CV253>0: Is the value in CV253 higher than 0, the locomotive continues to drive ahead for some time when entering the braking section to finally brake within the braking time indicated in CV253. The effort of the braking effect is now constant as set in CV253. The decoder changes the brake timing accordingly so that the locomotive stops at the correct position in the end. Figure 13 shows this quite clearly.

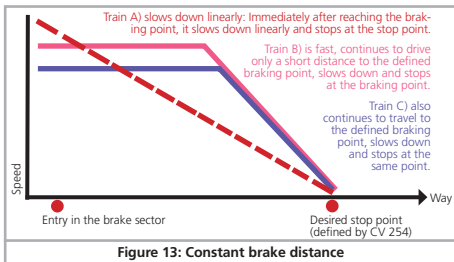

10.7. Settings for Analogue Operation

You can adjust the acceleration and maximum speed of the LokPilot separately for analogue DC and AC mode. Thus, you can adapt the speed of your locomotive also to analogue operations.

You will have to determine suitable values by trial and error since they depend on the type of transformer (throttle) and the drive system of your locomotive.

Please note that load compensation is always active ex works, even in analogue mode. This gives you smooth control even at very low speeds.

10.7.1. DC Analogue Operation

LokPilot V4.0

LokPilot V4.0 DCC

LokPilot micro V4.0

LokPilot micro V4.0 DCC

In DC analogue mode you can adjust the starting speed with the CVs 125 and the maximum speed with CV126.

10.7.2. AC Analogue Operation

LokPilot V4.0

In AC analogue mode you can adjust the starting speed with CV 127 and the maximum speed with CV 128.

11. Motor Control

LokPilot V4.0	LokPilot V4.0 DCC	
LokPilot micro V4.0	LokPilot micro V4.0 DCC	

5th generation load compensation enables LokPilot decoders to execute precise motor control. Even with the default settings, most locomotives run perfectly.

11.1. Adjusting Load Compensation

Should you find after programming and doing the initial test that the locomotive does not run smoothly particularly at low speed or that the locomotive jerks a little after having stopped or if you are simply unsatisfied with the driving performance, then you should adjust the load compensation of your LokPilot decoder.

Due to the large number of different types of motors and drive systems there is no single setting that suits all. Load compensation can be influenced with 5 CVs.



Firstly, check if the irregular performance is due to any mechanical faults. Bent driving rods are one common cause. When you turn off load compensation (set CV56 to 0) and the problem persists then it is likely there is a mechanical fault.

11.1.1. Parameter for frequently used Motors

We have listed the correct settings for the most common motors in table fig. 14. If a motor is missing, it means either that the default settings produce good results or that we have not yet sufficient experience about these motors.

Set the suitable values and test-drive your locomotive

11.1.2. Adjustments for other Motors / „Fine Tuning“

Unfortunately, the motors available in the market have considerable variations due to tolerances. This is even true for the same type. Therefore, LokPilot decoders enable you to adapt load compensation to the motor with CVs 53, 54 and 55. If the recom-

mended values above do not lead to acceptable results, you can further optimise them.

Especially for the slow driving sector (speed step 1) the LokPilot V4.0 with CV 52 to change the gain control. This helps to avoid any jerking while driving extremely slowly.



However, before doing this you must make sure that there are no capacitors wired between the motor terminals and the chassis. The commutator of the motor must be clean and the drive system should run freely. The wheel contacts and other contact plates of the locomotive must also be clean and make reliable contact.

11.1.2.1. Parameter „K“

Parameter „K“, stored in CV 54, influences how strongly load control will affect the driving performance. The higher the value, the more load control will respond to any changes and try to adjust the revs of the motor.

Parameter „K“ needs adjustment if the locomotive runs unevenly (jerks)

Reduce the value of CV 54 by 5 and test-run the locomotive to see if there are any improvements. Repeat these steps until the locomotive runs smoothly at speed step 1.

11.1.2.2. Parameter „I“

Parameter „I“, stored in CV 55 provides important information to the decoder on how much inertia the motor has. Motors with large flywheels naturally have more inertia than smaller ones or coreless motors.

Adjust parameter „I“ if the locomotive jerks somewhat just before it stops or „jumps“ at lower speeds (lower third of the speed step range) or simply does not run smoothly.

- Increase the value by 5 starting with the default value for motors with very small or no flywheels.
- Reduce the value by 5 starting with the default value for motors with large flywheels.

Test again and repeat this procedure until you arrive at the desired result.

11.1.2.3. Reference Voltage

In CV 53, you set the EMF reference voltage generated by the motor at maximum revs. This parameter may have to be adapted subject to the track voltage and the efficiency of the motor.

If the locomotive reaches maximum speed when the throttle is set to about a third and the top third of the throttle has no influence on the speed, then you should reduce the value of CV 53. Reduce the value by 5 – 8 and test the locomotive again. Repeat this process until the locomotive just reaches its maximum speed when the throttle is fully open.

11.1.2.4. Parameter “K slow”

Together with the LokPilot V4.0 decoder an additional CV 52 has been introduced which separately determines the gain control considerably for the whole slow driving sector in speed step 1. If you are not satisfied with the driving behaviour when the locomotive drives slowly or starts, while everything is fine with the medium and high speed steps, you should increase the value of CV 52 by ca. 5 - 10 than the value set in CV 54.

11.1.2.5. Adaptive Regulation Frequency

The decoder operates ex works with a mutable (adaptive) regulation frequency to drive the motor as precisely as possible. However, as a result some motors might show a nasty buzzing noise.

For such motors you are able to set the regulation frequency on a constant value. Set bit 4 to “1” in CV 124.

Type of motor	Remarks	CV 2	CV 52	CV 53	CV 54	CV 55	CV 56
Fleischmann® round motor		4	32	120	80	50	255
Märklin® SFCM small «Scheibenkollektormotor»	with magnet 51961	4	50	40	175	200	200
Märklin® SFCM big «Scheibenkollektormotor»	with magnet 51960	4	80	40	175	200	200
Märklin® DCM «Trommelkollektormotor»	with magnet 51962	4	80	40	175	200	200
Märklin® 5*-high-performance motor		3	32	120	60	95	255
Märklin® Locomotives with Maxon Motor		3	16	140	48	20	255
HAG® motors		4	15	100	40	175	200
Trix® Locomotives with Maxon Motor	Remove the motor EMC capacitors from the main board!	3	16	140	48	20	255
Faulhaber® motors		4	32	140	80	50	255

Figure 14: Chart of BACK-EMF settings for widely used motors

11.2. Turning off Load Compensation

LokPilot V4.0

LokPilot V4.0 DCC

LokPilot micro V4.0

LokPilot micro V4.0 DCC

You can also switch off load compensation by writing the value 0 in CV 56 („Control Influence“).



With load control turned off, the starting voltage in CV 2 should be increased until the locomotive starts moving at speed step 1 or 2.

11.3. Adapting Load Control Frequency

LokPilot V4.0

LokPilot V4.0 DCC

LokPilot micro V4.0

LokPilot micro V4.0 DCC

In the LokPilot decoders load control works normally with 40 kHz. Sometimes it can be useful to reduce this frequency by half:

- For motors with little power due to high inductivity.
- If suppressors (such as capacitors, chokes, etc.) disturb load control but cannot be removed (e.g. some older Gützold® locos).

Delete bit 1 in CV 49 in order to set the PWM frequency from 40 KHz to about 20 kHz.

11.4. Dynamic Drive Control: Up and Down the Hill

LokPilot V4.0

LokPilot V4.0 DCC

LokPilot micro V4.0

LokPilot micro V4.0 DCC

Dynamic Drive Control of your LokPilot decoder enables you to adapt load control, as you may desire. Full control over the entire speed range (constant speed, if enough power is available) is not always prototypical. Therefore you can set the degree to which load control will be effective between 0 (no load control) and 100% (load compensation over the full range).

At low speeds it is advisable to have 100% load compensation in order to prevent the locomotive from „getting stuck“ or from „running away“ without any load. The impact of load control should recede with increasing speed in order to have the full „unharnessed“ power of the motor available when the throttle is fully open. Thus, the locomotive will respond to certain changes in the main line such as gradients. The locomotive will run faster downhill and become slower climbing the hill.

The desired degree of load control influence is set in CV 56.



It is particularly meaningful to reduce the influence of load control whenever you run consists. This allows for better driving properties of all locomotives in the consist.

11.5. Settings for the C-Sinus Motor

LokPilot decoders with the 21MTC interface can drive the new C-Sinus motors indirectly via the circuit board installed in the locomotive. The LokPilot can generate all necessary signals provided you readjust certain settings:

Load compensation must be turned off as described in chapter 11.2.

The control electronics of the motor also need a switched logic voltage provided by the LokPilot on output AUX4. AUX4 must therefore be active while the locomotive is stopped and while it is moving (in both directions!)

LokPilot V4.0	LokPilot V4.0 DCC	
LokPilot micro V4.0	LokPilot micro V4.0 DCC	

Write the values below into the respective CVs.



Make sure that CV 31 contains the value 16 and CV 32 the value 2.

CV	Value
CV 266	32
CV 282	32
CV 298	32
CV 314	32

Use the LokProgrammer in order to activate AUX4 for the stationary locomotive and for the moving locomotive in both directions as shown in Fig. 15.

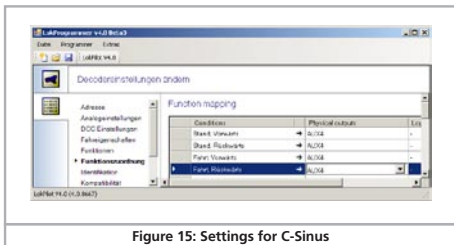

Figure 15: Settings for C-Sinus

12. Function outputs

12.1. Physical function outputs

LokPilot decoders have up to 6 physical function outputs. „Head lights“ and „Rear lights“ are used for lighting, the remaining ones (AUX1 to AUX4) are freely available. Other functions include „Shunting Mode“, „Acceleration / Deceleration On/Off“ as well as virtual functions like „Sound On/Off“. We explain the importance of the latter in chapter 14.

The function buttons („F buttons“) of your command station or throttle activate the function outputs.

Generally, F0 is the lighting button, while we count the remaining buttons from F1 upwards.

12.2. Allocation of Function Buttons (Function Mapping)

LokPilot V4.0	LokPilot V4.0 DCC	
LokPilot micro V4.0	LokPilot micro V4.0 DCC	

You can allocate the functions freely to any function button. ESU uses the so-called and once more extended „Mapping“ for the LokPilot V4.0 decoder. It has the advantage that you can link each output to any button. Furthermore, the allocation can vary between forward and reverse as well. It is also possible to switch several functions simultaneously. Unfortunately this kind of flexibility requires a large amount of CVs. The solution of this problem is called „Index CV access“.

12.2.1. Index CV access

The CVs ranging from 257 – 511 have a special: They are „indexed“. This means, that the meaning of any of these CVs can change depending on the value of the so-called „Index register“.

By changing the value of the index register, also the meaning and the value of the CV itself is changed. This method allows us to use every CV between 257 -511 multiple times and solves the the

problem regarding the lack of CVs.

The CVs 31 and 32 are so-called index registers which determine the meaning of CV 257 - 511. With every change of CV31 and CV 32 you also change the meaning and the values of CV 257 - 511 simultaneously.

The meaning of all other CVs (1 - 256) is not influenced by the value of the index register.



So before you read or write any of the CVs located in the range of 257 - 511, please make sure that you set the index register to the correct value first.

12.2.2. Function Mapping Chart

Please refer to the chart on page 40/41 to get an overview of the possible options. Each function key can control more than one output. There are 4 types of "outputs":

- Physical outputs: There are six real outputs on the LokSound Select decoder. You can use them for lighting effects, smoke units or couplers etc.
- Logical functions: Such as Dynamic "shunting mode", "start and braking mode" and so on. These functions have a direct influence on the decoders behavior.
- Modifier Functions: Functions such as "Full brightness" are used in combination with other functions.

An output can also be controlled by more than one function key. The keys are "logical OR linked" together. This means that either key will turn an output on, however, to turn off the output again, all function keys have to be turned off as well.

To determine the correct CV values, go ahead as follows:

- Find the column in the chart corresponding to the output you wish to control.
- Identify the line corresponding to the function key you wish to use for the selected output.
- Note the numbers at the intersection of the line and the column you have selected.
- Program the Control CV listed left aside the noted number. Before you write this CV, make sure the index registers CV31 and CV 32

have the value shown left aside the Control CV number.

For each function key, there are 3 control CVs. Each function key exists twice, one for driving forwards and one for driving backwards. You should set the unneeded CVs to zero to avoid an unexpected behaviour of the decoder.

Example: Switch AUX3 with F8.

You want to switch AUX3 with the F8 key, either when you drive forwards and backwards. With the help of the ESU adapter board 51968 you added a light bulb to AUX3.

We can see from the chart, that CV 330 must be set to the value 16 to switch AUX3 via F8 to drive forward. In addition to this, CV 346 must be also set to the value 16 to switch AUX3 via F8 to drive backwards.

12.2.3. Allocation of Function Keys with the LokProgrammer

The LokPilot V4.0 can, if used with the ESU LokProgrammer and its new software version 4.0, be programmed more flexibly. It is e.g. possible to use several function keys at the same time as entry and thus allows to realise very specific wishes. However, it is widely impossible to make certain entries with the digital command station only. We therefore recommend to use our LokProgrammer, if your expectations exceed to the possibilities described in this manual.

Especially to operate the function keys F14 - F28 you have to use the LokProgrammer.

Function Outputs

12.3. Special Effects on Function Outputs

12.3.1. Switching on Outputs and Different Options

Each function output can / must be unlocked prior to using it. Furthermore, each output offers the choice of a lighting effect or can be additionally occupied with logical functions such as "Grade Crossing" or "High beam".

The following lighting effects are available:

- Dimmable light: A normal continuous output. The brightness will be reduced to about 50% if the dimmer function is on.
- Dimmable headlight with "fade in/out": Here the output is switched on slowly and imitates the slow glowing of oil lamps or very old light bulbs. The brightness will be reduced to about 50% if the dimmer function is on.
- Single Strobe: This is a single strobe light (short flashing) output. The frequency can be adjusted.
- Double Strobe: This will result in two short flashes. The frequency can be adjusted.
- Rotary Beacon: This effect should simulate a revolving reflector and bulb assignment of a very popular warning beacon atop many diesels of the 60's and 70's.
- Prime Stratolight: This is the more modern version of the Rotary beacon.
- Ditch Light Type 1: The ditch light type 1 will revert to a steady On state when it is not flashing.
- Ditch Light Type 2: The ditch light type 2 will revert to Off state when it is not flashing.
- Blinklicht: This is the "classical" flashing light. The frequency can be adjusted.
- Mars Light: This effect simulates the sweeping pattern of this well-known warning beacon in the USA.
- Gyra Light: The Gyra Light is similar to the Mars Light, but is slower in motion.
- Coupler function: You can use this function to control Krois® or ROCO® couplers, also in connection with automatic pushing/removing.

12.3.2. Adjusting the Lighting Effects

The LokPilot V4.0 provides 3 CVs for each physical output, which defines their behavior.

- Mode Select: Defines which effect you want to have for the output.
- Brightness: Defines the brightness of each individual function output in 32 steps (0 to 31).
- Special functions: Defines some further modes for each function output.

Have a look at the chart figure 14 to see how this works.

The CV for special functions needs to be explained in more detail. The special functions are additional functions you could add to each output.

- Phase Select: Alters the timing of the effect so that it is 180 degree out of phase with other effects. This allows you to create alternate blinking. It is used for ditch lights mainly.
- Grade Crossing: Causes the lighting effect to become active only when the global flag "Grade crossing enable" is set AND the corresponding function key is ON. Grade crossing logic can be used with any of the light effects. Grade Crossing can be used with most of the lighting effects.
- Rule 17 Forward: Applicable only if the output is set to either "Dimmable headlight" or "Dimmable headlight with fade in / out". Causes the effect to be dimmed to around 60% of the set brightness, if the locomotive is stopped. When the engine is running forward, the output will be increased to a 100%.
- Rule 17 Reverse: Like Rule 17 Forward, but the brightness will be increased to a 100% when the locomotive drives backwards.
- Dimmer: Causes the output to be dimmed to around 60% of the defined brightness, if the global flag "Dimmer" is set. With this function you are able to realise a full beam very easily by setting the the

Fig. 16: Function Mapping - Factory default values for LokPilot V4.0

Function Button	Description	CV 32	Control CV	Physical function outputs								CV 32	Control CV
				Head Light	Backup Light	AUX1	AUX2	(AUX3)	(AUX4)	(AUX5)	(AUX6)		
FS(f)	Stand forward	2	266	1	2	4	8	16	32	64	128	2	268
FS(r)	Stand backward	2	282	1	2	4	8	16	32	64	128	2	284
FF(f)	Fahrt forward	2	298	1	2	4	8	16	32	64	128	2	300
FF(r)	Fahrt backward	2	314	1	2	4	8	16	32	64	128	2	316
F0	Licht forward	2	330	1	2	4	8	16	32	64	128	2	332
F0	Licht backward	2	346	1	2	4	8	16	32	64	128	2	348
F1	F1 forward	2	362	1	2	4	8	16	32	64	128	2	364
F1	F1 backward	2	378	1	2	4	8	16	32	64	128	2	380
F2	F2 forward	2	394	1	2	4	8	16	32	64	128	2	396
F2	F2 backward	2	410	1	2	4	8	16	32	64	128	2	412
F3	F3 forward	2	426	1	2	4	8	16	32	64	128	2	428
F3	F3 backward	2	442	1	2	4	8	16	32	64	128	2	444
F4	F4 forward	2	458	1	2	4	8	16	32	64	128	2	460
F4	F4 backward	2	474	1	2	4	8	16	32	64	128	2	476
F5	F5 forward	2	490	1	2	4	8	16	32	64	128	2	492
F5	F5 backward	2	506	1	2	4	8	16	32	64	128	2	508
F6	F6 forward	3	266	1	2	4	8	16	32	64	128	3	268
F6	F6 backward	3	282	1	2	4	8	16	32	64	128	3	284
F7	F7 forward	3	298	1	2	4	8	16	32	64	128	3	300
F7	F7 backward	3	314	1	2	4	8	16	32	64	128	3	316
F8	F8 forward	3	330	1	2	4	8	16	32	64	128	3	332
F8	F8 backward	3	346	1	2	4	8	16	32	64	128	3	348
F9	F9 forward	3	362	1	2	4	8	16	32	64	128	3	364
F9	F9 backward	3	378	1	2	4	8	16	32	64	128	3	380
F10	F10 forward	3	394	1	2	4	8	16	32	64	128	3	396
F10	F10 backward	3	410	1	2	4	8	16	32	64	128	3	412
F11	F11 forward	3	426	1	2	4	8	16	32	64	128	3	428
F11	F11 backward	3	442	1	2	4	8	16	32	64	128	3	444
F12	F12 forward	3	458	1	2	4	8	16	32	64	128	3	460
F12	F12 backward	3	474	1	2	4	8	16	32	64	128	3	476
F13	F13 forward	3	490	1	2	4	8	16	32	64	128	3	492
F13	F13 backward	3	506	1	2	4	8	16	32	64	128	3	508

Logik functions 1

Logik functions 1										Logik functions 2							
ABV On / Off	Shunting mode	Dynamic brake	Reserved	Reserved	Reserved	Dimmer	Grade Crossing	CV32	Control CV	Reserved	Reserved	Reserved	Reserved	Reserved	Reserved	Reserved	Shift Mode
1	2	4	8	16	32	64	128	2	269	1	2	4	8	16	32	64	128
1	2	4	8	16	32	64	128	2	285	1	2	4	8	16	32	64	128
1	2	4	8	16	32	64	128	2	301	1	2	4	8	16	32	64	128
1	2	4	8	16	32	64	128	2	317	1	2	4	8	16	32	64	128
1	2	4	8	16	32	64	128	2	333	1	2	4	8	16	32	64	128
1	2	4	8	16	32	64	128	2	349	1	2	4	8	16	32	64	128
1	2	4	8	16	32	64	128	2	365	1	2	4	8	16	32	64	128
1	2	4	8	16	32	64	128	2	381	1	2	4	8	16	32	64	128
1	2	4	8	16	32	64	128	2	397	1	2	4	8	16	32	64	128
1	2	4	8	16	32	64	128	2	413	1	2	4	8	16	32	64	128
1	2	4	8	16	32	64	128	2	429	1	2	4	8	16	32	64	128
1	2	4	8	16	32	64	128	2	445	1	2	4	8	16	32	64	128
1	2	4	8	16	32	64	128	2	461	1	2	4	8	16	32	64	128
1	2	4	8	16	32	64	128	2	477	1	2	4	8	16	32	64	128
1	2	4	8	16	32	64	128	2	493	1	2	4	8	16	32	64	128
1	2	4	8	16	32	64	128	2	509	1	2	4	8	16	32	64	128
1	2	4	8	16	32	64	128	3	269	1	2	4	8	16	32	64	128
1	2	4	8	16	32	64	128	3	285	1	2	4	8	16	32	64	128
1	2	4	8	16	32	64	128	3	301	1	2	4	8	16	32	64	128
1	2	4	8	16	32	64	128	3	317	1	2	4	8	16	32	64	128
1	2	4	8	16	32	64	128	3	333	1	2	4	8	16	32	64	128
1	2	4	8	16	32	64	128	3	349	1	2	4	8	16	32	64	128
1	2	4	8	16	32	64	128	3	365	1	2	4	8	16	32	64	128
1	2	4	8	16	32	64	128	3	381	1	2	4	8	16	32	64	128
1	2	4	8	16	32	64	128	3	397	1	2	4	8	16	32	64	128
1	2	4	8	16	32	64	128	3	413	1	2	4	8	16	32	64	128
1	2	4	8	16	32	64	128	3	429	1	2	4	8	16	32	64	128
1	2	4	8	16	32	64	128	3	445	1	2	4	8	16	32	64	128
1	2	4	8	16	32	64	128	3	461	1	2	4	8	16	32	64	128
1	2	4	8	16	32	64	128	3	477	1	2	4	8	16	32	64	128
1	2	4	8	16	32	64	128	3	493	1	2	4	8	16	32	64	128
1	2	4	8	16	32	64	128	3	509	1	2	4	8	16	32	64	128

Function Outputs

LED mode: global function "Dimmer" with a function key. The outputs are pre-set to be used with incandescent bulbs. If you wire LEDs on the output, you should set the LED compensation mode bit in order to get satisfying characteristics. The light effects will be accordingly adjusted, so that the result will look more realistic again.

For each physical output, the three controlling CVs are defined as follows:

Function output	Mode Select CV	Brightness CV	Special function CV
Head light	259	262	263
Rear light	267	270	271
AUX1	275	278	279
AUX2	283	286	287
AUX3	291	294	295
AUX4	299	302	303



Please set index register CV 31 to 16 and CV 32 to 0 before changing any of the above-mentioned CVs.

Light effect	Mode Select	Brightness	Special function					
			Phase select	Grade XING	Rule 17 Fw	Rule 17 Rev	Dimmer	LED mode
Dimmable headlight	1	0-31	1	2	4	8	16	128
Dimmable headlight (fade in/out)	2	0-31	1	2	4	8	16	128
Fire box	3	0 - 31	1	2			16	128
Smart fire box	4	0 - 31	1	2			16	128
Single Strobe	5	0-31	1	2	4	8	16	128
Double Strobe	6	0-31	1	2			16	128
Rotary Beacon	7	0-31	1	2			16	128
Strato Light	8	0-31	1	2			16	128
Ditch Light Typ 1	9	0-31	1	2			16	128
Ditch Light Typ 2	10	0-31	1	2			16	128
Flash light	12	0-31	1	2			16	128
Mars Licht	13	0-31	1	2			16	128
Gyra Licht	14	0-31	1	2			16	128
Coupler function	28	0 - 31	1	2			16	128

Figure 17: Light effects for function outputs and the according special functions

Function Outputs

In order to set each output, you should proceed as follows:

1. From the chart fig. 16 on the previous page, select the value for the Mode Select CV.
2. Compute the value for the Special Function CV by adding the values you can find in the chart figure 17 below the corresponding special function.
3. Define the value for the desired brightness.
4. Write the values into the CV corresponding to the appropriate function output.

Repeat these steps for all 6 function outputs you want to configure.

Example: Double Strobe with LEDs on AUX4

We want to set up AUX4 to create a Double strobe output. We want to use an LED.

1. Using figure 16, we find that the Mode Selection CV must be set to 5.
2. We find out that for LED compensation mode, we should set the Special function CV to 128.
3. We want to have a brightness level of 25.
4. Using the table on the left side, we find that the Mode Select CV for AUX4 is 299. We set CV 299 = 5. We also find that the brightness CV is 302 and set it to 25. Finally, the Special function CV for AUX4 is 303 and needs to be set to 128.

12.3.3. Grade Crossing holding time

You can define the for time the global grade crossing function as you like. By doing so, the "Grade Crossing" will remain active, also after switching off the function key. This will create a very interesting game effect. The desired value will be stored in CV 132. The value of CV 132 multiplied with 0.0625 seconds defines the time. The default value 80 results in 5.2 seconds.

12.3.4. Flash Rate

You can also set the flash rate for all lighting effects globally. All effects will flash or strobe at the same rate. The desired value should be stored in CV 112. The value of CV 112 multiplied with 0.065536 seconds (65,536ms) defines the flash rate. The default value 30 results in 1.97 seconds.

12.3.5. Digital Couplers

LokPilot V4.0	LokPilot V4.0 DCC	
LokPilot micro V4.0	LokPilot micro V4.0 DCC	

Some LokPilot decoders can directly control digital couplers. Subject to the type of coupler, you must adjust certain settings.

12.3.5.1. „Coupler“ Mode

Krois® and ROCO® couplers need a special high frequency PWM signal to avoid burning the copper windings of the coil. This special function „Coupler“ provides this type of signal. In this mode, the output switches on at 100% for 250 ms and then reduces the output power by switching to the PWM-signal. The ratio between Off and On time can be set by adjusting the „Brightness Value“ from 0 (completely off) to 31 (connected through = 100% output).

This coupler mode should also be used for modern Telex®-couplers.

12.3.5.2. Automatic Coupler Function (Pushing/Removing)

The LokPilot V4.0 decoder is able to do the automatic decoupling. When you push the function button the loco drives backwards against the train and then removes from it again. This procedure can be influenced via three CVs.

In [CV246](#) the speed that moves the loco will be stored (or defined) (0-255). If this value is 0, the automatic coupler function is not active.

In [CV 247](#) the time of pushing is to be entered.

In [CV248](#) the time of removing is to be entered.

The time of pushing should be higher than the time of removing to make sure that the loco stops in a safe distance away from the train.



The function output of the options „pulse“ or „coupler“ needs to be configured correctly to make the automatic decoupling work.

Analogue Settings & LGB® Pulse Sequence Mode & Swiss Headlight Mode

12.4. Analogue Settings

LokPilot V4.0	LokPilot V4.0 DCC	
LokPilot micro V4.0	LokPilot micro V4.0 DCC	

With the CVs 13 and 14, you can predetermine which function buttons should be switched in analogue mode. Thus, you „simulate“ pressing an F button. The ex works default settings switch on the directional headlights (F0 is on!) as well as F1 (ex works allocated to AUX1).

Analogue Function Control 1

CV #	F1	F2	F3	F4	F5	F6	F7	F8
13	1	2	4	8	16	32	64	128

Analogue Function Control 2

CV #	F0(f)	F0(r)	F9	F10	F11	F12		
14	1	2	4	8	16	32		

12.5. LGB® Pulse Sequence Mode

LokPilot V4.0	LokPilot V4.0 DCC	
LokPilot micro V4.0	LokPilot micro V4.0 DCC	

It is possible to switch to pulse sequence mode for operations with the LGB® command station and the Roco® Lokmaus I. To do so, set bit 5 in CV 49. From now on decoder counts the number of times the F1 button is pressed in order to activate the desired function. Thus, it is possible to reach all function buttons by repeated pushing of the F1 button.

12.6. Swiss Headlight Mode

LokPilot V4.0	LokPilot V4.0 DCC	

Function mapping enables you to set many different configurations. The Swiss headlight mode is a good example. We need a third lighting circuit that switches the left lower headlight of the „A“ - headlight configuration whenever the lights are turned on. This third circuit must work independently from the direction of travel.

Figure 18 shows one option of how to wire this arrangement with AUX1 (green wire) being used for the third circuit. All you have to do now is to program the decoder in such a way that it always switches on that third circuit when the lighting function is active. In order to do so enter value 5 in CV 298 and the value 6 in CV 314. (Don't forget to firstly set the index register CV 31 to value 16 and CV 32 to value 2!). That's it!

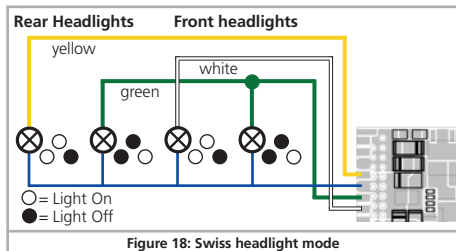

Figure 18: Swiss headlight mode

13. Decoder Reset

You can reset decoder to the default settings at any time.

13.1. With DCC Systems or 6020/6021

Enter the value 08 in CV 08.

13.2. With Märklin® systems (mfx®-decoder)

Mfx® decoders can be reset to factory default values with the Central Station® or the Mobile Station® via the reset command in the locomotive menu.

13.3. With the ESU LokProgrammer

(From software 2.7.3.): In the menu „Programmer“, select option „Reset decoder“ and follow the instructions on the screen.

14. Special Functions

You may not yet be aware of some other highly specialised functions offered by LokPilot decoders.

14.1. Directional Bit

The directional bit determines the driving behaviour when transitioning from an analogue into a digital sector (also refer to chapter 10.4.3.). If you want to set this directional bit, then bit 0 in CV 124 must be set.

15. RailCom®

LokPilot V4.0	LokPilot V4.0 DCC	
LokPilot micro V4.0	LokPilot micro V4.0 DCC	

RailCom® was developed by Lenz® Elektronik, Giessen, Germany, and is a technology for transmitting information from the decoder back to the command station. Until now DCC systems could only transmit data from the command station to the decoder but could never be sure if the decoder actually received the commands.

The locomotive can send the following information to the command station:

Locomotive address: The decoder transmits its address on request by „Broadcast“. Detectors in a certain track sector can detect this command. Thus, the command station can find out the location of that particular locomotive.

CV information: The decoder can provide feedback about all CV values to the command station per RailCom®. In future, a programming track will not be necessary any more.

Meta data: The decoder can transmit status information such as motor load, current draw of the motor, temperature etc. to the command station.

In order for RailCom® to work all decoders and the command station must be equipped accordingly. LokPilot decoders are RailCom®-ready in terms of their hardware. However, it may be necessary to carry out a firmware update in order to activate it. Relevant information regarding the status of the implementation of RailCom® is available on our homepage.

Prior to use RailCom® must be unlocked by setting bit 3 in CV 29. CV 28 offers further options. Ex works, RailCom® is not active in ESU decoders.

16. Firmware Update

You can update LokPilot decoders with new operating software (so-called firmware) at any time. This is useful for fixing bugs and implementing new functions.

You can carry out the update yourself for free without having to remove the decoder from the locomotive. All you need is the ESU LokProgrammer. The software of the LokProgrammer will keep your LokPilot decoder up-to-date. A separate download is therefore not necessary.

Updates which are carried out by our service department will not be treated as a case of warranty. Therefore we will charge you for this service.

17. Accessories

You will get detailed information regarding accessories at your dealer or on our homepage.

17.1. Switching the Centre pick-up

The circuit board 51966 for switching the centre pick-up only for the decoder with the 21MTC interface is intended for vehicles with two pick-ups. Thus, you can activate the forward pick-up in the direction of movement. This is ideal for block control!

17.2. HAMO Magnets

One cannot drive the universal motors in many Märklin® models directly with a LokPilot decoder. Firstly, you must replace the stator coil with a permanent magnet. ESU supplies the following magnets:

51960	Permanent magnet as 220560, for rotor 217450, D=24,5mm, for motor plate 216730, 211990, 228500
51961	Permanent magnet as 220450, for rotor 200680, D=18,0mm, for motor plate 204900
51962	Permanent magnet as 235690, for rotor 231440, D=19,1mm, for motor plate 231350

17.3. Wire Harnesses with 8-pole or 6-pole Socket

If the locomotive you want to convert does not have an interface and you do not want to remove the plug from the decoder then you can use the harness 51950 or 51951: First install the suitable harness and then plug in the decoder.

17.4. Mounting Adapter 21MTC

If you wish to convert a locomotive with a LokPilot decoder with the 21MTC interface, the adapter plate 51967 comes in handy: it has a socket for plugging in the LokPilot but also has solder points for connecting the original wiring of the locomotive. This is ideal for converting Märklin® locomotives.

With article no. 51968 we offer an adapter board which amplifies both the outputs AUX3 and AUX4 through a transistor and are therefore accessible. Ideal for complex conversions!

19. Support and Assistance

Your model train dealer or hobby shop is your competent partner for all questions regarding your LokPilot decoder. In fact he is your competent partner for all questions around model trains.

There are many ways to get in touch with us. For enquiries please use either email or fax (don't forget to provide your own fax-no. or email address) and we will reply within a few days.

Please call our hotline only in case of complex enquiries that can't be dealt with by email or fax. The hotline is often very busy and you may encounter delays. Rather send an email or fax and also check our website for more information. You will find many hints under "Support / FAQ" and even feedback from other users that may help you with your particular question.

Of course we will always assist you; please contact us at:

USA & Canada (English support), please contact:

Phone: +1 (570) 649-5048
Tuesday & Thursday 9:00am - 3:00pm (CT)
Fax: +1 (866) 591-6440
Email: support@loksound.com
Mail: ESU LLC
477 Knopp Drive
US-PA-17756 Muncy

Germany and all other countries, please contact:

Phone: ++49 (0) 700 - 56 57 68 63
Tuesday & Wednesday 10:00am - 12:00am
Fax: ++49 (0) 700 - 37 87 25 37
Email: support@esu.eu
Mail: ESU GmbH & Co. KG
- Technischer Support -
D-89081 Ulm

www.esu.eu

20. Technical Data

	LokPilot V4.0	LokPilot V4.0 DCC	LokPilot micro V4.0	LokPilot micro V4.0 DCC
Operation Voltage	5 – 40V	5 – 27V	5-21V	5 – 21V
DCC operation using 14/28/128 Fahrstufen, 2-digit and 4-digit addresses; automatic recognition of operational mode	Ok	Ok	Ok	Ok
Digital Motorola®, with 14/28 speed steps, address range for Motorola®-mode	Ok 255	-	Ok 255	-
M4-operation with automatic recognition	-	-	-	-
Selectrix®-operation	Ok	-	Ok	-
Analog DC Operation	Ok	Ok	Ok	Ok
Analog AC Operation	Ok	-	-	-
DCC programming	Ok	Ok	Ok	Ok
Motorola®-Programming mode using 6021, Mobile Station or Central Station possible	Ok	-	Ok	-
Mfx® programming procedure	-	-	-	-
Märklin® brake section	Ok	-	Ok	-
Brake on DC, Roco® brake section	Ok	Ok	Ok	Ok
Selectrix® brake mode (with diodes)	Ok	-	Ok	-
Lenz® ABC brake mode	Ok	Ok	Ok	Ok
Shunting mode / Starting - braking times switchable	Ok	Ok	Ok	Ok
RailCom® Option	Ok	Ok	Ok	Ok
Continuous motor load	1.1A	1.1A	0.75A	0.75A
5th generation back-EMF control, overload protected	20/40 kHz	20/40 kHz	20/40 kHz	20/40kHz
Function outputs	4/250 mA	4/250mA	2/150 mA	2/150mA
Total load of all function outputs	280mA	500mA	280mA	280mA
Supported function keys (mappable)	F0 - F15	F0 - F15	F0 - F15	F0-F15
Integrated PowerPack backup capacitor	-	-	-	-
PowerPack optional	Ok	Ok	-	-
Dimensions in mm:	21.3x15.5x5.5	21.3x15.5x5.5	10.5x8.1x2.8 Next18:15.0x9.5x2.8	10.5x8.1x2.8 Next18:15.0x9.5x2.8

21. List of all supported CVs

21.1. DCC Decoders

On the following pages, we have listed all CVs of LokPilot decoders in a chart. Please refer to the CV concept as outlined in chapter 5.1. Please only change CVs if you are certain about their purpose and the impact of your action. Wrong CV settings can lead to impaired performance or may cause your LokPilot not to respond at all.

CV	Name	Description	Range	Value
1	Primary address	Address of engine (For LokPilot V4.0, LokPilot XL V3.0: Range 1 - 255)	1 - 127	3
2	Start voltage	Sets the minimum speed of the engine	1 - 255	3
3	Acceleration	This value multiplied by 0.25 is the time from stop to maximum speed	0 - 255	32
4	Deceleration	This value multiplied by 0.25 is the time from maximum speed to stop	0 - 255	24
5	Maximum speed	Maximum speed of the engine	0 - 64	64
6	Medium speed	Medium speed of engine	0 - 64	22
7	Version number	Internal software version of decoder	-	-
8	Manufacturer's ID	Manufacturers's ID ESU - Writing value 8 in this CV triggers a reset to factory default values	151	-
13	Analogue mode F1-F8	Status of functions F1 to F8 in analogue mode (see chapter 12.4)	0-255	1
14	Analogue mode FL, F9-F12	Status of function F0, F9 to F12 in analogue mode (see chapter 12.4)	0-63	3
17 18	Extended engine address	Long address of engine (see chapter 9.2)	128 - 9999	192
19	Consist Address	Additional address for consist operation. Value 0 or 128 means: consist address is disabled 1 – 127 consist address active, normal direction 129 – 255 consist address active reverse direction	0-255	0
21	Consist mode F1-F8	Status of functions F1 to F8 in Consist mode Meaning of the bits as in CV 13 (see chapter 12.4)	0-255	0
22	Consist Mode FL, F9-F12	Status of functions FL, F9 to F12 in Consist mode Meaning of the bits as in CV 14 (see chapter 12.4)	0-63	0

List of all supported CVs (DCC Decoders)

CV	Name	Description	Range	Value				
27	Brake mode	Allowed brake modes		28				
		Bit			Function	Value		
		0			ABC braking, voltage higher on the right hand side	1		
		1			ABC braking, voltage higher on the left hand side	2		
		2			ZIMO® HLU brakes active	4		
		3			Brake on DC, if polarity against driving direction	8		
		4			Brake on DC, wenn Polarität gleich wie Fahrtrichtung	16		
28	RailCom® Configuration	Settings for RailCom®		3				
		Bit			Function	Value		
		0			Channel 1 Address broadcast disabled Channel 1 Address broadcast enabled	0 1		
		1			No data transmission allowed on Channel 2 Data transmission allowed on Channel 2	0 2		
29	Configuration register	The most complex CV within the DCC standards. This register contains important information, some of which are only relevant for DCC operation.		12				
		Bit			Function	Value		
		0			Normal direction of travel Reversed direction of travel	0 1		
		1			14 speed steps DCC 28 or 128 speed steps DCC	0 2		
		2			Disable analog operation Enable analog operation	0 4		
		3			Disable RailCom® Enable RailCom®	0 8		
		4			Speed curve through CV 2, 5, 6 Speed curve through CV 67 - 94	0 16		
		5			Short addresses (CV 1) in DCC mode Long addresses (CV 17 + 18) in DCC mode	0 32		
		31			Index register H	Selection page for CV257-512	16	16

List of all supported CVs (DCC Decoders)

CV	Name	Description	Range	Value		
32	Index register L	Selection page for CV257-512	0, 2, 3	0		
49	Extended Configuration #1	Additional important settings for LokPilot Decoders	0 - 255	19		
		Bit			Description	Value
		0			Enable Load control (Back-EMF) Disable Load control (Back-EMF)	1 0
		1			DC Motor PWM frequency 20kHz motor pulse frequency 40 kHz motor pulse frequency	0 2
		2			Märklin® Delta Mode Disable Märklin® Delta Mode Enable Märklin® Delta Mode	0 4
		3			Märklin® 2nd address Disable Märklin® 2nd address Enable Märklin® 2nd address	0 8
		4			Automatic DCC speed step detection Disable DCC speed step detection Enable DCC speed step detection	0 16
		5			LGB® function button mode Disable LGB® function button mode Enable LGB® function button mode	0 32
		6			Zimo® Manual Function Disable Zimo® Manual Function Enable Zimo® Manual Function	0 64
		7			Reserved	0 128
50	Analogue mode	Selection of allowed analogue modes	0 - 3	3		
		Bit			Function	Value
		0			AC Analogue Mode (if implemented, refer to section 7.3.) Disable AC Analog Mode Enable AC Analog Mode	0 1
1	DC Analogue mode Disable DC Analogue mode Enable DC Analogue Mode	0 2				

List of all supported CVs (DCC Decoders)

CV	Name	Description	Range	Value
52	Load control parameter «K» for slow driving	„K“-component of the internal PI-controller for the low speed steps. Defines the effect of load control. The higher the value, the stronger the effect of Back EMF control.	0 - 255	32
53	Control Reference voltage	Defines the Back EMF voltage, which the motor should generate at maximum speed. The higher the efficiency of the motor, the higher this value may be set. If the engine does not reach maximum speed, reduce this parameter.	0 - 255	140
54	Load control parameter „K“	„K“-component of the internal PI-controller. Defines the effect of load control. The higher the value, the stronger the effect of Back EMF control.	0 - 255	48
55	Load control parameter „I“	„I“-component of the internal PI-controller. Defines the momentum (inertia) of the motor. The higher the momentum of the motor (large flywheel or bigger motor diameter, the lower this value has to be set.	0 - 255	32
56	Operating range of load control	0 – 100 % Defines up to which speed in % load control will be active. A value of 32 indicates that load control will be effective up to half speed.	1 - 255	255
66	Forward Trimm	Divided by 128 is the factor used to multiply the motor voltage when driving forward. The value 0 deactivates the trim.	0 - 255	128
67-94	Speed table	Defines motor voltage for speed steps. The values „in between“ will be interpolated.	0 - 255	-
95	Reverse Trimm	Divided by 128 is the factor used to multiply the motor voltage when driving backwards. Value 0 deactivates the trim.	0 - 255	128
112	Blinking light	Blinking frequency of Strobe effects. Always a multiple of 0.065536 seconds.	4 - 64	30
105	User CV #1	Free CV. Here you are able to save what ever you want.	0 - 255	0
106	User CV #2	Free CV. Here you are able to save what ever you want.	0 - 255	0
113	Power Fail Bypass	The time that the decoder bridges via the PowerPack after an interruption of voltage. Unit: A multiple of 0.016384 sec.	0 - 255	50

List of all supported CVs (DCC Decoders)

CV	Name	Description	Range	Value		
124	Extended Configuration #2	Additional important settings for LokPilot Decoders		-	0	
		Bit	Description			Value
		0	Bi-directional bit: Enable driving direction when shifting direction Disable driving direction			1 0
		1	Disable decoder lock with CV 15 / 16 Enable decoder lock with CV 15 / 16			0 2
		2	Disable erial protocol for C-Sinus Enable erial protocol for C-Sinus			0 4
		4	Adaptive regulation frequency Constant regulation frequency	0 16		
125	Starting voltage Analog DC		0-255	30		
126	Maximum speed Analog DC		0-255	130		
127	Starting voltage AC	(not for LokPilot V4.0 DCC)	0-255	50		
128	Maximum speed Analog AC	(not for LokPilot V4.0 DCC)	0-255	150		
132	Grade Crossing Holding Time	Grade Crossing holding time. See chapter 12.3.3.				
246	Automatic decoupling Driving speed	Speed of the loco while decoupling; the higher the value, the faster the loco. Value 0 switches the automatic coupler off. Automatic decoupling is only active if the function output is adjusted to „pulse“ or „coupler“.	0 - 255	0		
247	Decoupling - Removing time	This value multiplied with 0.016 defines the time the loco needs for moving away from the train (automatic decoupling).	0 – 255	0		
248	Decoupling - Pushing time	This value multiplied with 0.016 defines the time the loco needs for pushing against the train (automatic decoupling).	0 – 255	0		
253	Constant brake mode	Determines the constant brake mode. Only active, if CV254 >0		0 – 255	0	
		Function	CV 253 = 0: Decoder stops linearly CV 253 > 0: Decoder stops constantly linear			
254	Constant stopping distance	A value > 0 determines the way of brake distance it adheres to, independent from speed.	0 – 255	0		

22. Appendix

22.1. Programming Long Addresses

As described in chapter 9.2, the long address is split into two CVs. The byte with the higher value of the address is in CV 17. This byte determines the range in which the extended address will be located. For instance, if you enter the value 192 in CV 17 then the extended address may be between 0 and 255. If 193 is written into CV 17 then the extended address will be between 256 and 511. You can continue this up to addresses with values of 9984 and 10239. The possible values are shown in Fig. 19.

22.1.1. Write address

To program a long address you first of all need to calculate the values for CV 17 and CV 18 and then program it. Please note that it is not possible to program addresses via the programming mode "POM".

To program the long address proceed as follows:

- First you determine the desired address, for instance 4007.
- Then you look for the appropriate address range in Fig. 19. The value to be entered into CV 17 can be found in the column on the right. In our example, it is 207.

The value for CV 18 is established as follows:

	desired address	4007
minus	first address in the address range -	3840
	=====	====
equals	value for CV 18	167

- 167 is therefore the value to be entered in CV 18. Thus you decoder is now programmed to address 4007.

22.1.2. Read out address

If you wish to read out the address of a locomotive please read the values of CV 17 and CV 18 one after another and proceed then in reverse order:

Let's assume you have read:

CV 17 = 196; CV 18 = 147. Look up the corresponding address range in Fig. 19. The first possible address within this range is 1024. Then you have to add the value from CV 18 and you arrive at the locomotive address:

$$\begin{array}{r}
 1024 \\
 + 147 \\
 \hline
 = 1171
 \end{array}$$

AdressRange			AdressRange			AdressRange		
from	to	CV17	from	to	CV17	from	to	CV17
0	255	192	3584	3839	206	7168	7423	220
256	511	193	3840	4095	207	7424	7679	221
512	767	194	4096	4351	208	7680	7935	222
768	1023	195	4352	4607	209	7936	8191	223
1024	1279	196	4608	4863	210	8192	8447	224
1280	1535	197	4864	5119	211	8448	8703	225
1536	1791	198	5120	5375	212	8704	8959	226
1792	2047	199	5376	5631	213	8960	9215	227
2048	2303	200	5632	5887	214	9216	9471	228
2304	2559	201	5888	6143	215	9472	9727	229
2560	2815	202	6144	6399	216	9728	9983	230
2816	3071	203	6400	6655	217	9984	10239	231
3072	3327	204	6656	6911	218			
3328	3583	205	6912	7167	219			

Figure 19: Chart of extended loco addresses!

23. Warranty Certificate

24 months warranty form date of purchase

Dear customer,

Congratulations on purchasing this ESU product. This quality product was manufactured applying the most advanced production methods and processes and was subjected to stringent quality checks and tests.

Therefore ESU electronic solutions ulm GmbH & Co. KG grants you a warranty for the purchase of ESU products that far exceeds the national warranty as governed by legislation in your country and beyond the warranty from your authorised ESU dealer. ESU grants an extended

manufacturer's warranty of 24 months from date of purchase.

Warranty conditions:

- This warranty is valid for all ESU products that have been purchased from an authorised dealer.
- No claims will be accepted without proof of purchase. The filled in warranty certificate together with your ESU dealer's receipt serves as proof of purchase. We recommend keeping the warranty certificate together with the receipt.
- In case of claim please fill in the enclosed fault description as detailed and precise as possible and return it with your faulty product.

Extend of warranty / exclusions:

This warranty covers free of charge repair or replacement of the faulty part, provided the failure is demonstrably due to faulty design, manufacturing, material or transport. Please use the appropriate postage stamps when shipping the decoder to ESU. Any further claims are excluded.

The warranty expires:

1. In case of wear and tear due to normal use
2. In case of conversions of ESU - products with parts not approved by the manufacturer.
3. In case of modifications of parts, particularly missing shrink sleeves, or wires directly extended on the decoder.
4. In case of inappropriate use (different to the intended use as specified by the manufacturer).
5. If the instructions as laid down in the user manual by ESU electronic solutions ulm GmbH & Co. KG were not adhere to.

Due to liability reasons any inspections or repairs can only be carried out on products that are not installed in a locomotive or carriage. Any locomotive sent to ESU for inspection will be returned without even touching it. There is no extension of the warranty period due to any repairs or replacements carried out by ESU.

You may submit your warranty claims either at your retailer or by shipping the product in question with the warranty certificate, the receipt of purchase and fault description directly to ESU electronic solutions ulm GmbH & Co. KG:

ESU GmbH & Co. KG
- Garantieabteilung -
Industriestraße 5
D-89081 Ulm
GERMANY

Trouble shooting sheet

1. Personal data











(Please write in block letters)

Name:
Street:
ZIP/City: | | | | |
Country:
Email:
Phone:
Date:
Signature:

2. Product details and system environment (use extra page if needed)

Art.No.:	Purchase Date:	Address:
Operation Mode: <input type="checkbox"/> AC Analogue	<input type="checkbox"/> AC Digital	<input type="checkbox"/> DC Analog
Digital system: <input type="checkbox"/> ESU ECoS	<input type="checkbox"/> Märklin® 6012	<input type="checkbox"/> ROCO® Digital
<input type="checkbox"/> Intellibox®	<input type="checkbox"/> Lenz® Digital	<input type="checkbox"/> Others:
		<input type="checkbox"/> DC Digital (DCC)
		<input type="checkbox"/> LGB® Digital <input type="checkbox"/> LGB® MZS

3. Error description

<input type="checkbox"/> Headlight output front 	<input type="checkbox"/> No Sound 	<input type="checkbox"/> Cable 
<input type="checkbox"/> Headlight output rear 	<input type="checkbox"/> Wrong Sound 	<input type="checkbox"/> Change direction probl 
<input type="checkbox"/> Motor output 	<input type="checkbox"/> Short circuit 	<input type="checkbox"/> Without any function (DOA)
<input type="checkbox"/> Programming 	<input type="checkbox"/> AUX output 	<input type="checkbox"/> Other problems:

4. Receipt - Proof of purchase (Please enclose this document!)

Please enclose your receipt / invoice. Otherwise no warranty possible!

5. Additional information:

.....
.....
.....
.....
.....
.....

6. Your retailer:

.....
.....
.....
.....
.....
.....

Retailer's stamp or address

